

**DANCOVER<sup>®</sup>**

**.com**

Manual  
for  
Storage Tent PRO  
8x12x5,2m PVC

# DANCOVER<sup>®</sup>

.com

## Safety Advice

### Attention

In some countries approval is needed to set up a tent larger than 75 m<sup>2</sup>. It is your responsibility to comply with local rules and regulations and to ensure that the tent is assembled correctly.

In case of bad weather conditions, it is your responsibility to ensure the tent is safely secured and that the tent does not cause damage to others.

Do not use open fire, welding equipment or other sources which can ignite, inside or close to the tent.

The tent must be safely secured. We recommend you secure your tent with straps and pegs as soon as it is assembled.

Make sure to check if the tent is covered by your home contents insurance.

Tents must be evacuated under extreme weather conditions.

In the event of snow, always remove snow from the roof of the tent regularly to prevent snow from building on the roof, as heavy snow can cause the tent to collapse.

In the event of rain, there is a risk of rain puddles building up on top of the roof of the tent. Heavy rain puddles can cause the roof to collapse. It is your responsibility to ensure rain puddles do not build up. As a precaution, make sure the roof of the tent is stretched out properly and adequately over the side frames of the tent and remove rain water regularly.

Do not unpack or repack your tent in freezing temperatures. In case of temperatures below zero, always unpack and repack your tent indoors to avoid the risk of cracking parts.

The tent must be totally dry before you repack and store it to avoid mildew.















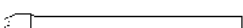
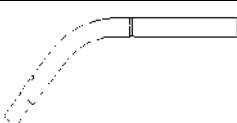

**Note:** Dancover warranty applies only to the normal use of the Product, normal wear and tear excepted, in accordance with written use instructions or manual. The warranty does not apply to damage caused by accident, abuse, misuse, or modification of the Product.





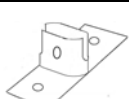
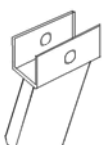





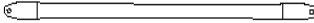



## Warranty Information

Please visit [dancovershop.com](http://dancovershop.com) for information on warranty.

*Please always check our website for the latest safety advice and manual.*

# Instruction

			8x12
1	Back leg		4
2	Back leg		18
3	Extension pipe		22
4	Crossbar		16
5	Ceiling rail		11
6	Ceiling rail		11
7	Corner arch		22
8	Center arch		11
9	Connecting pipe		117
10	Connecting pipe		13
11	Extension pipe		22
12	Extension pipe		4
13	Door pillar		4
15	Fasten bar		20
16	Foot base		26
17	Connecting component		4
18	Nail 10x350mm		16
19	Nail 6x180mm		60
20	Nail 7x300mm		52

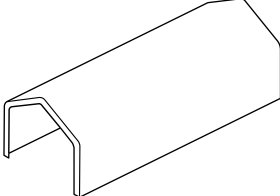
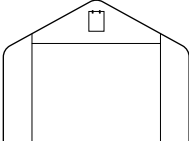
21	Spiral nail 10x700mm		4
22	Cross bar		8
23	1.75" Screw		12
24	2.5" Screw		40
25	4" Screw		148
26	Wing nut		200
27	Floor Bracket (set of 2 pcs)		8
28	Bungee ball		92
29	Spanner		2
30	Bolt with nut		34
31	Tie-down kit		4
32	Steel clip		40
33	Steel wire		12
34	Rope		4
35	Rope		4
36	Roof		1
37	Endwall		2

8m storage pro	Part 23	Part 24	Part 25	Part 26	Part 30
	M6x45 Screw	M6x65 Screw	M6x105 Screw	M6 Wing nut	M8×55 Bolt with nut
	8x12m	8x12m	8x12m	8x12m	8x12m
Used for Part 5 and Part 6	11			11	
Used for Part 3 and Part 5		11		11	
Used for Part 3 and Part 6		11		11	
Used for Part 1 and Part 22		4		4	
Used for Part 12 and Part 22		4		4	
Used for Part 1 and Part 10			4	4	
Used for Part 7 and Part 10			2	2	
Used for Part 3 and Part 10			4	4	
Used for Part 11 and Part 10			2	2	
Used for Part 8 and Part 10			1	1	
Used for Part 1 and Part 9			4	4	
Used for Part 2 and Part 9			36	36	
Used for Part 7 and Part 9			20	20	
Used for Part 3 and Part 9			40	40	
Used for Part 11 and Part 9			20	20	
Used for Part 8 and Part 9			10	10	
Used for Part 1 and Part 16					4
Used for Part 2 and Part 16					18
Used for Part 13 and Part 22					4
Used for Part 12 and Part 17					4
	11	30	143	184	30

## Attention

Please use gloves when assembling the metal frame of this unit. The metal components of this product have been treated, with a rust preventive coating. This coating is not dangerous, but you may grease your hands during assembly. We recommend that you wipe metal parts clean with a mixture of warm water and dish detergent prior to assembly. Should your hands become dirty, simply wash with soap and water.

After the frame is set up, it should look like the picture shown below.

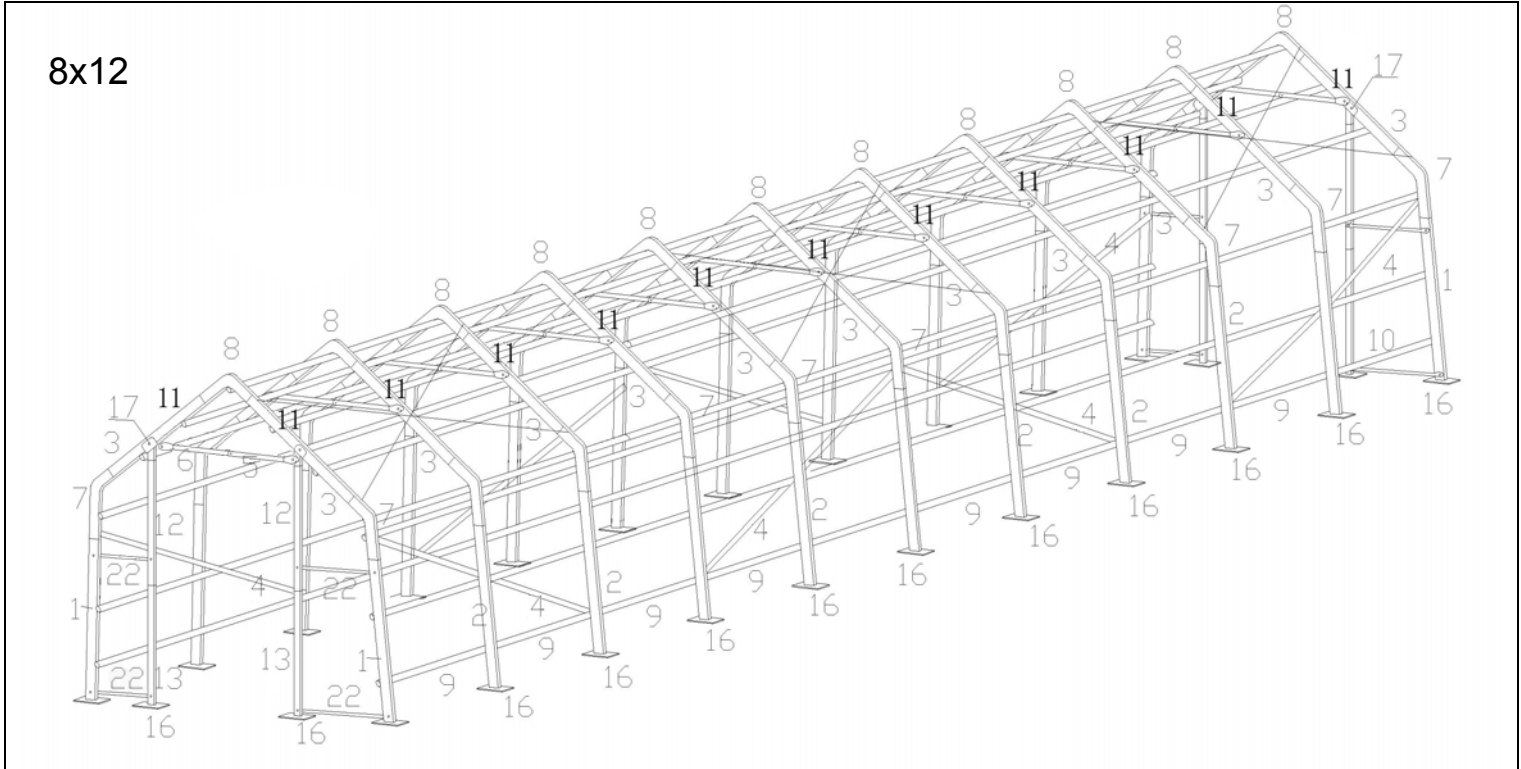

Please assemble the frame in these steps. All sizes have similar assemble step.

**Step 1**

When assembling the tent, make sure that all the wing nuts are attached to the inside.  
Connect one center arch pipe(8) with the extension pipe(11). Attach the corner arch(7) to the ends of the extension pipe(3). Now connect the ceiling rail(6 and 5) with each other using the 1.75" screw and the wing nuts. Connect extension pipe (3) and (11) together then attach ceiling rail to extension pipe(3 and 11) through 17 using the 2.5" screws and wing nuts.

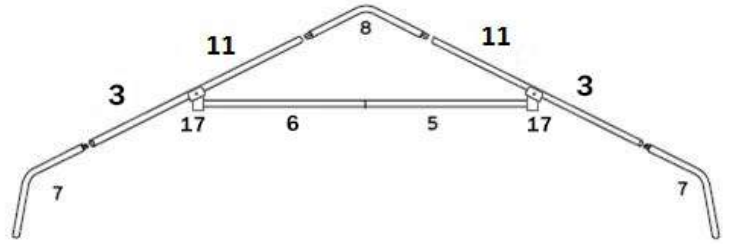

**Step 2,**

Repeat step 1 for the next elements and place them on the ground one after another, as illustrated.

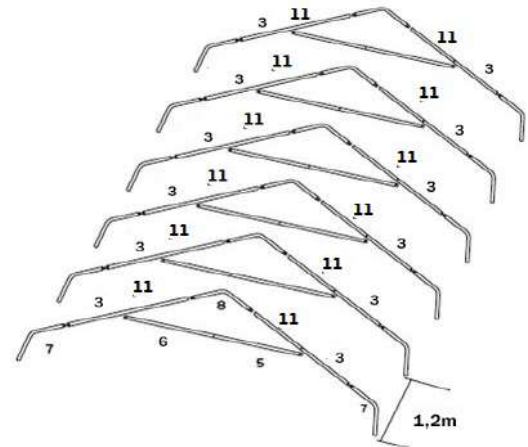

**Step 3,**

Now connect the arch elements with each other using the connecting pipes (9 and 10). Note that only corner arch 10 are used for the front segments. Use the 4" screw and wing nut to tighten them.

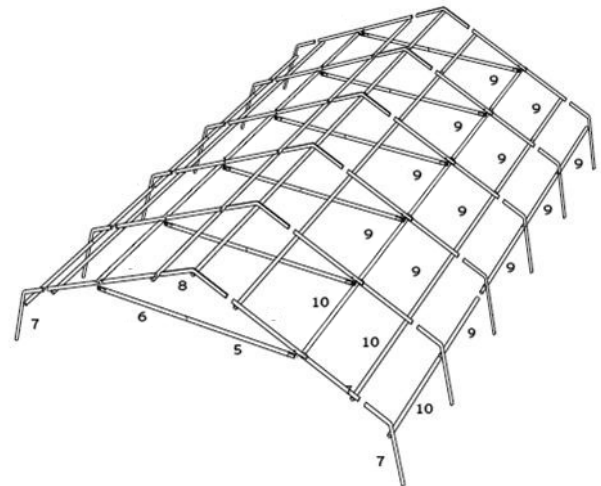

**Step 4,**

Strengthen the frame with steel wire.

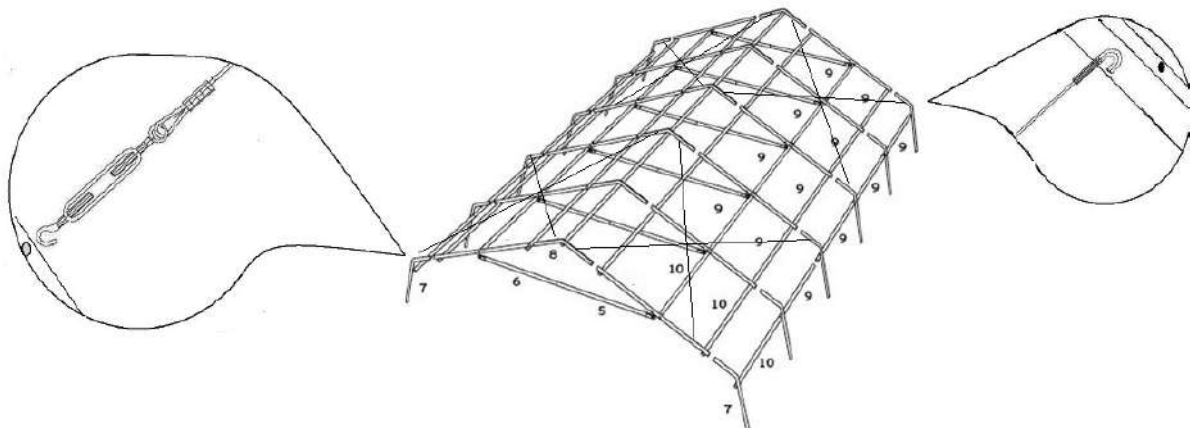

**Step 5,**

Start setting up one side first. Connect the corner arch (7) with the legs (1 and 2). Secure the frame using the connecting pipes (9 and 10). Attach the diagonal pipes (4) to the back legs (1). Please refer to the completed frame pictures to attach the diagonal pipes.

Screw tighten the tent at the feet, using the 4" screws and wing nuts.

Use the floor bracket and the 10x350mm pegs to fasten the frame to the ground.

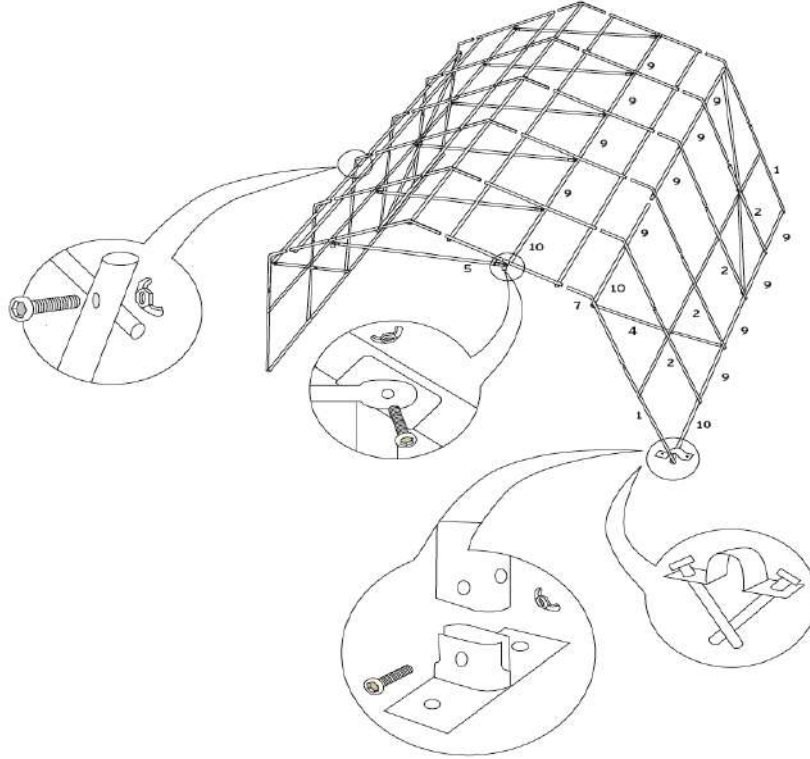

**Step 6,**

Unfold the tent cover and put it over the frame. Insert the fasten bar (15) into the loop at the lower end of roof and fasten it with steel clips. Attach the end wall to the frame using the bungees. Tension the roof cover to the tent frame to the ground using the 6x180mm pegs.

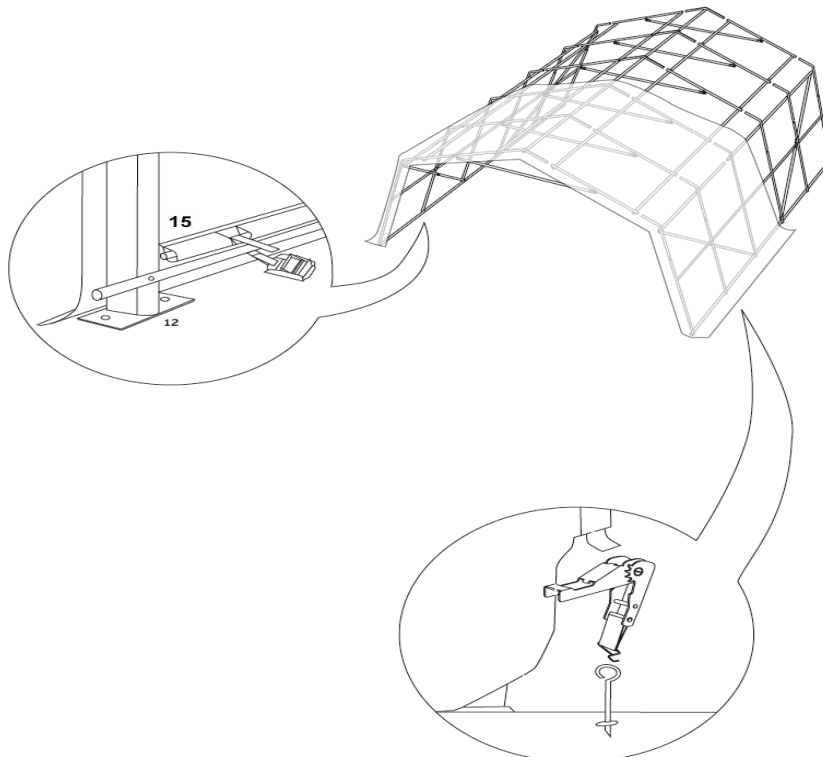



**Step 7,**  
Assemble the pillar set like on the picture below.

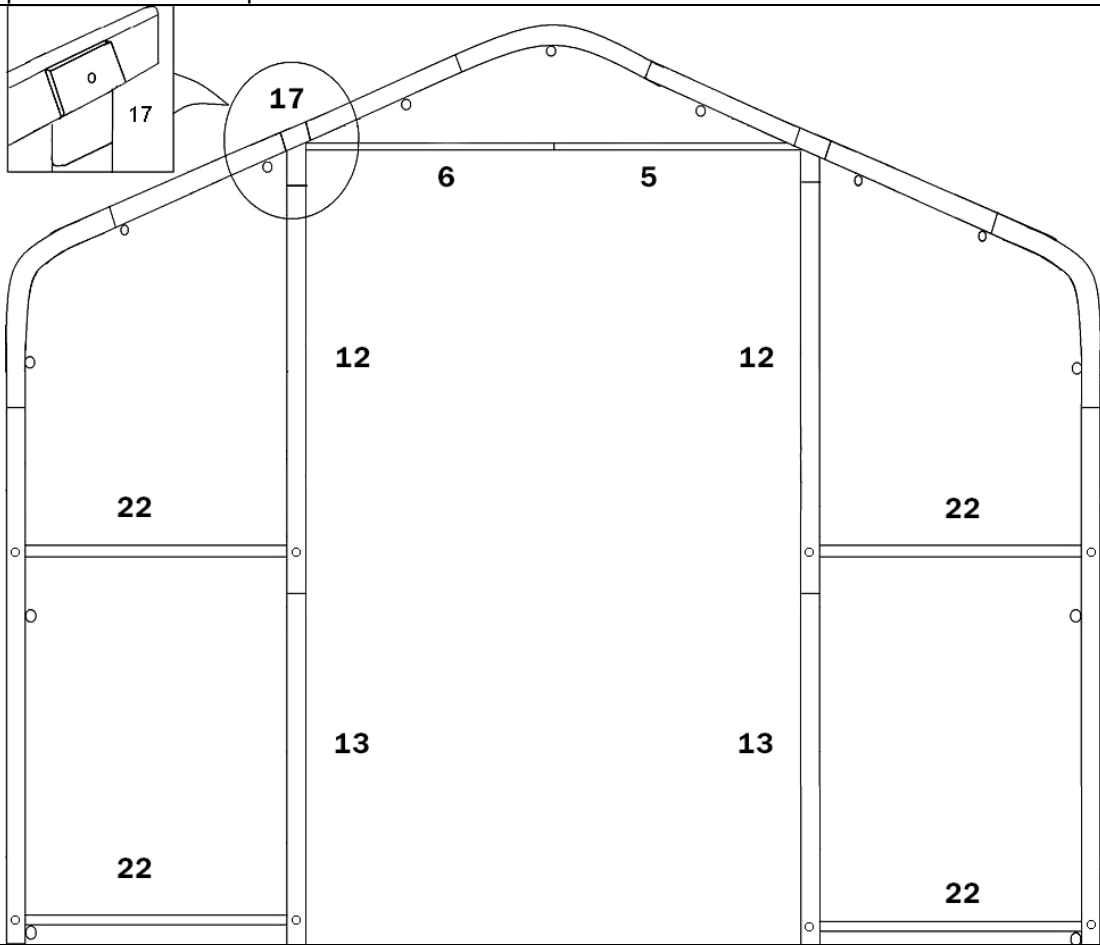

**Step 8,**  
Use the ropes to attach the door and cover to the frame. Find a proper way and strength to attach the cover to the frame carefully. Please do not use too much strength to tear the eyelet out of fabric.

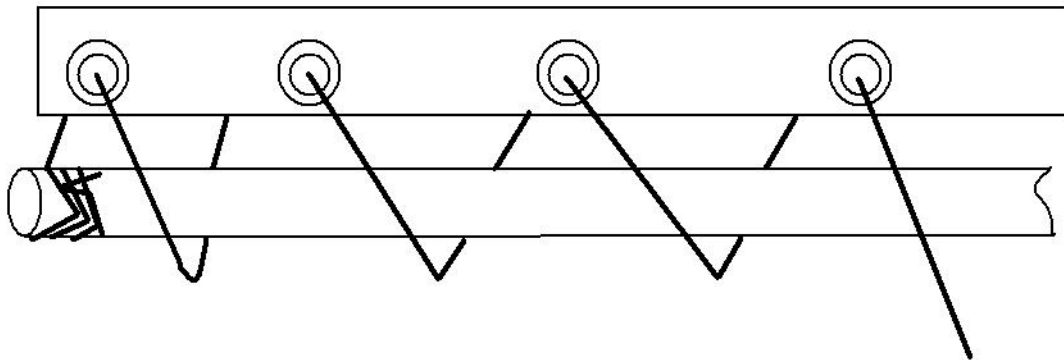

## Contact information

Head office:

Dancover A/S  
Lyngevej 16A, Nørre Herlev  
3400 Hillerød  
Denmark

For more information  
please visit:  
[www.dancovershop.com](http://www.dancovershop.com)

## National contact

Denmark:

[denmark@dancover.com](mailto:denmark@dancover.com)

UK:

[uk@dancover.com](mailto:uk@dancover.com)

Germany:

[germany@dancover.com](mailto:germany@dancover.com)

France:

[france@dancover.com](mailto:france@dancover.com)

Sweden:

[sverige@dancover.com](mailto:sverige@dancover.com)

Finland:

[suomi@dancover.com](mailto:suomi@dancover.com)

Poland:

[polska@dancover.com](mailto:polska@dancover.com)

Luxembourg:

[luxembourg@dancover.com](mailto:luxembourg@dancover.com)

Portugal:

[portugal@dancover.com](mailto:portugal@dancover.com)

Spain:

[espana@dancover.com](mailto:espana@dancover.com)

Italy:

[italia@dancover.com](mailto:italia@dancover.com)

Switzerland:

[schweiz@dancover.com](mailto:schweiz@dancover.com)

Austria:

[austria@dancover.com](mailto:austria@dancover.com)

Norway:

[norge@dancover.com](mailto:norge@dancover.com)

Nederland:

[nederland@dancover.com](mailto:nederland@dancover.com)

Ireland:

[ireland@dancover.com](mailto:ireland@dancover.com)

Belgium:

[belgique@dancover.com](mailto:belgique@dancover.com)