

MODULARO™

WOODEN GAZEBO LORRAINE

3.47 x 3.47 x 3.45 m

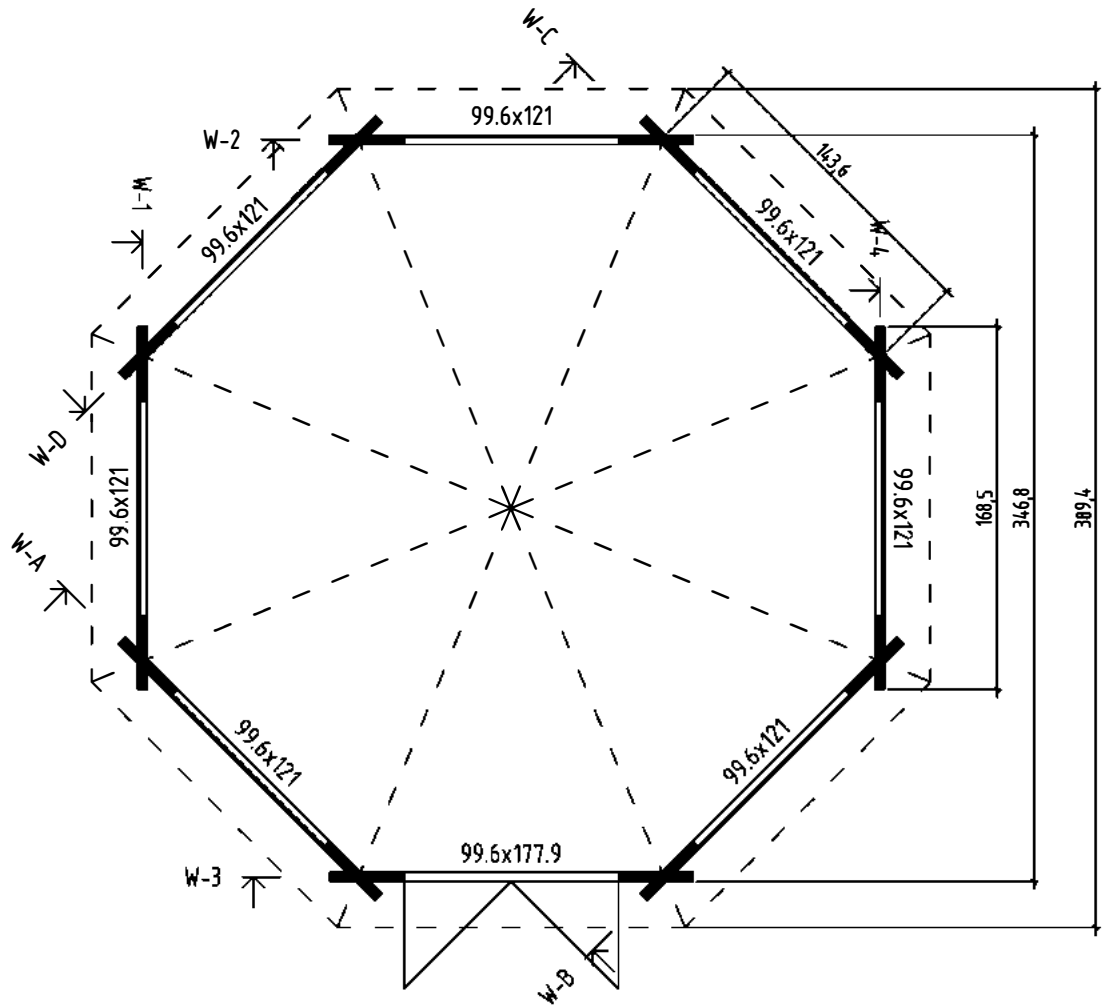



Foundation - Fundament - Fondation - Fondamenta - Fundering - Alusraam

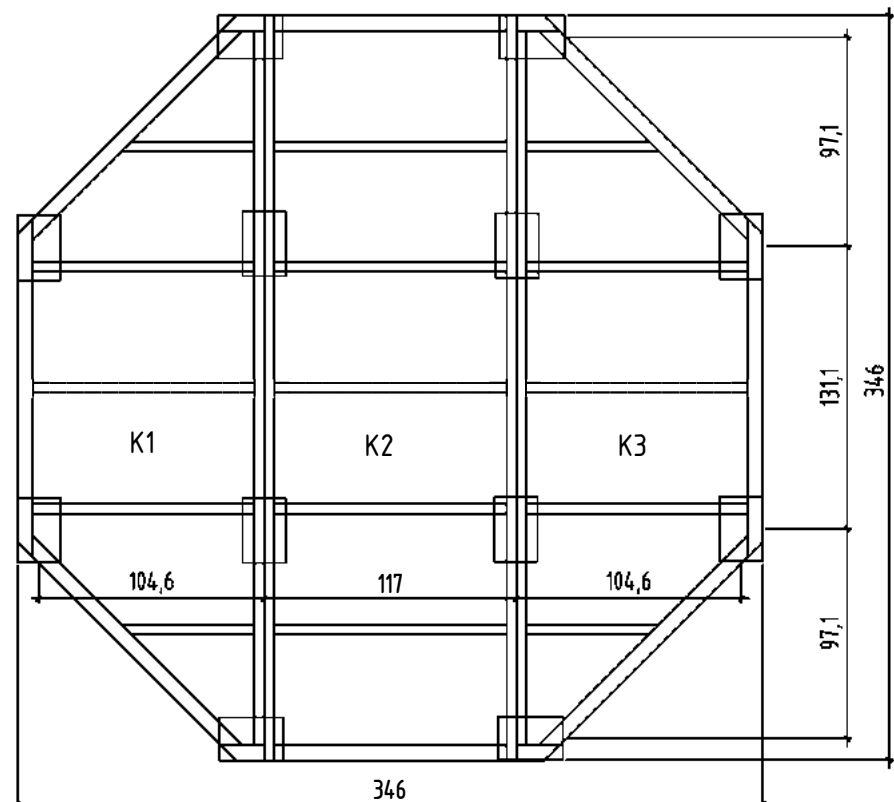

Floor element - Bodenelement - Plancher pré-monté -
Parti per pavimento - Vloer element - Põrandakilp

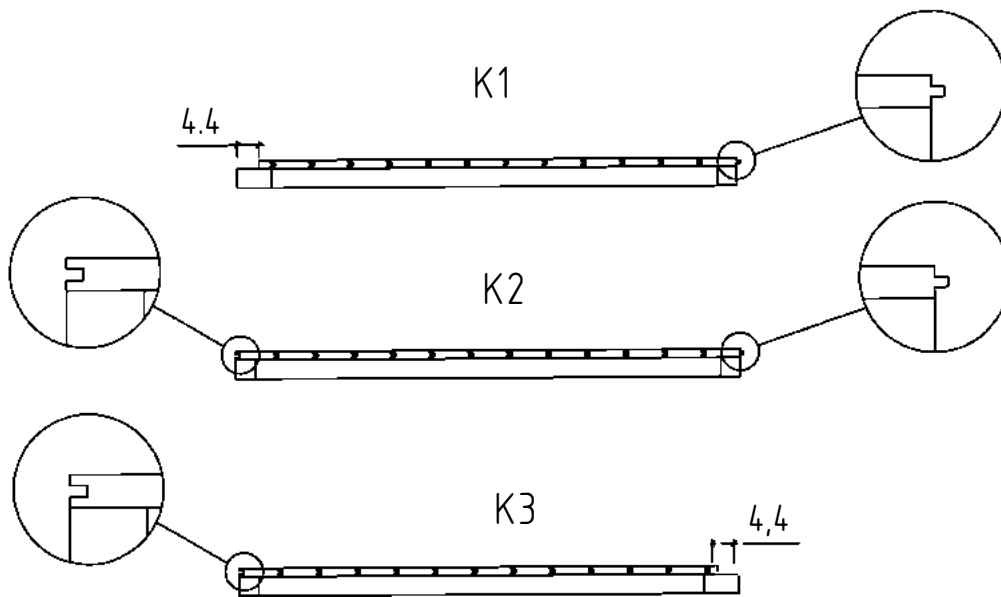
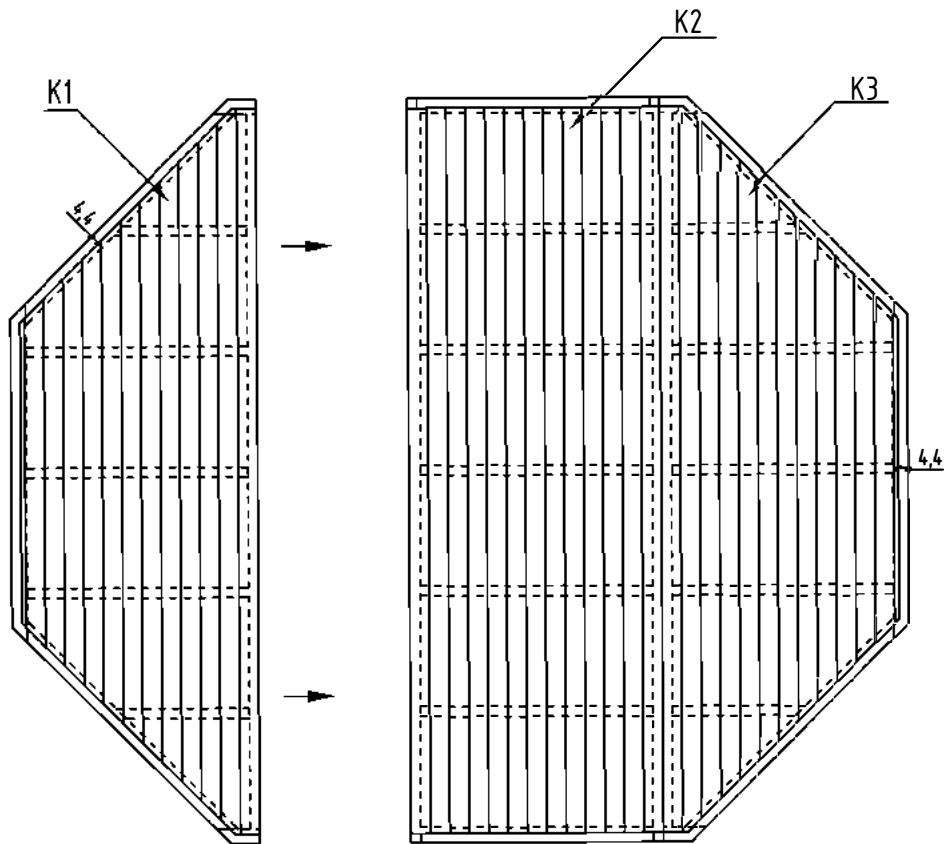

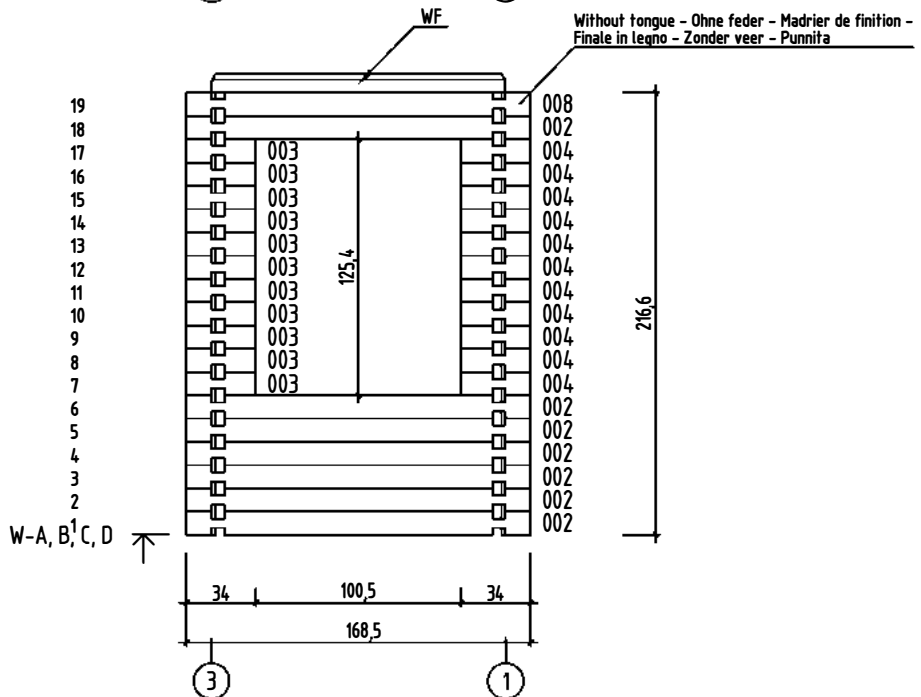
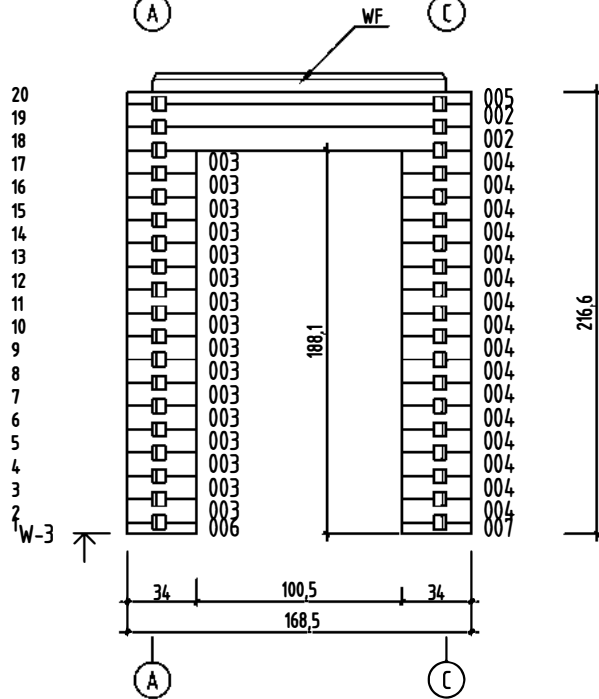
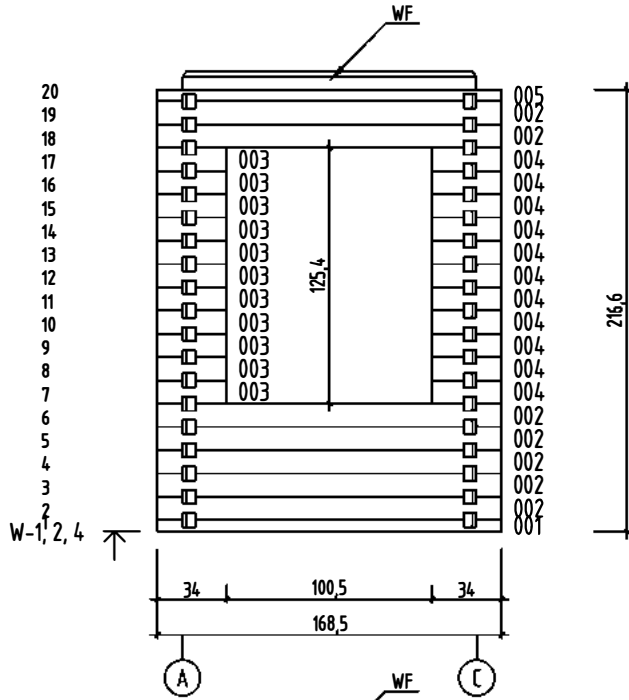

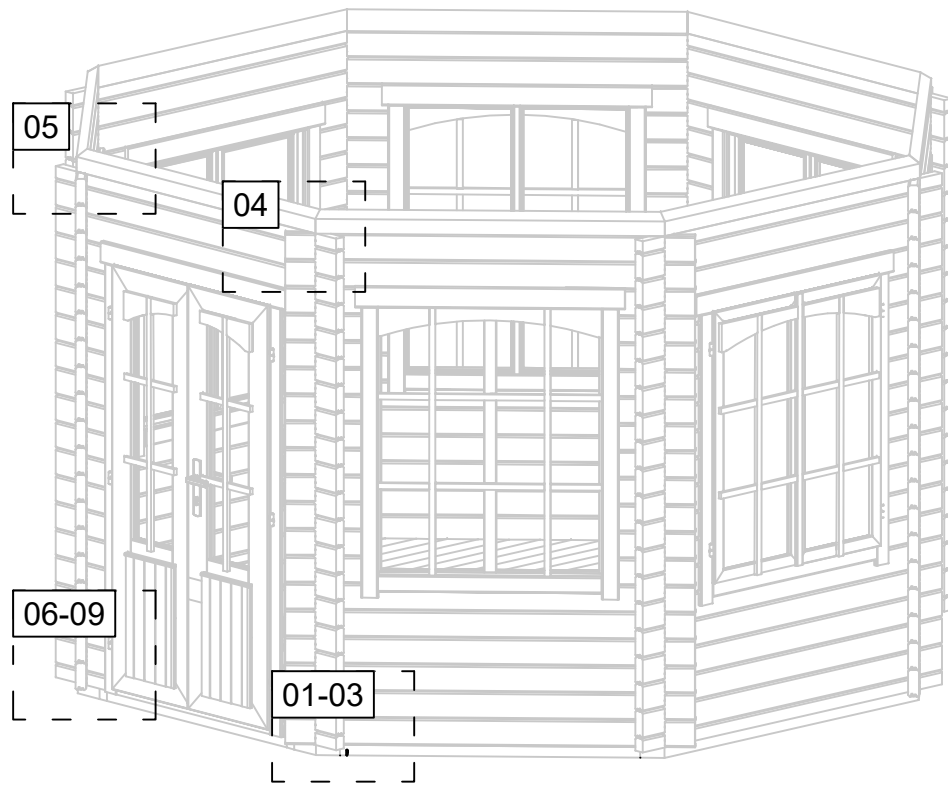

01

02

SPC

SSP

03

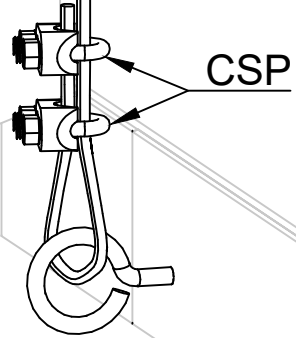

04



05

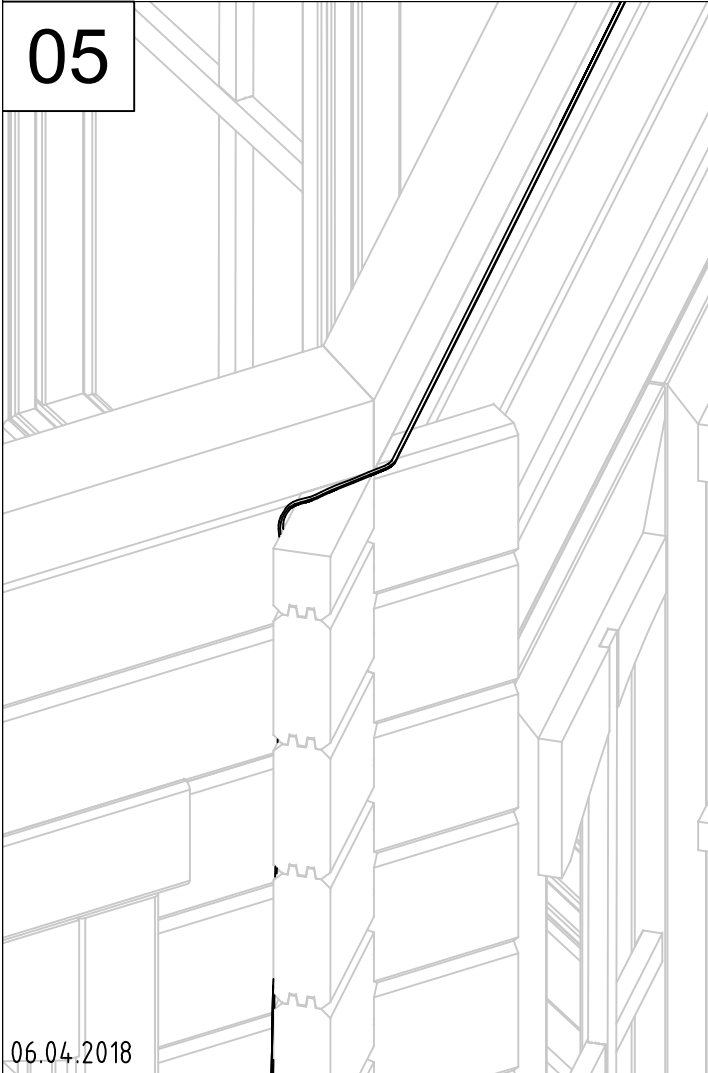

06

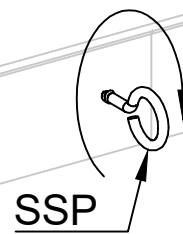

07

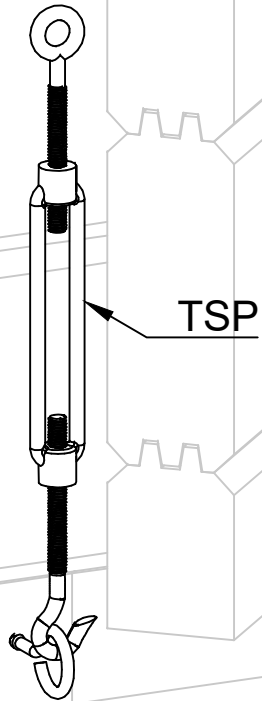

08

SPC

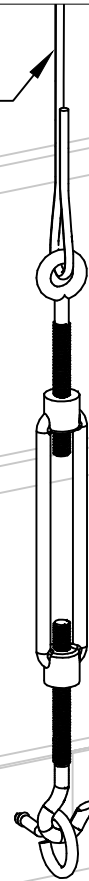

09

CSP

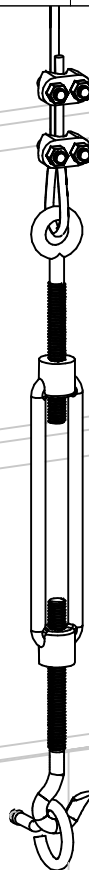

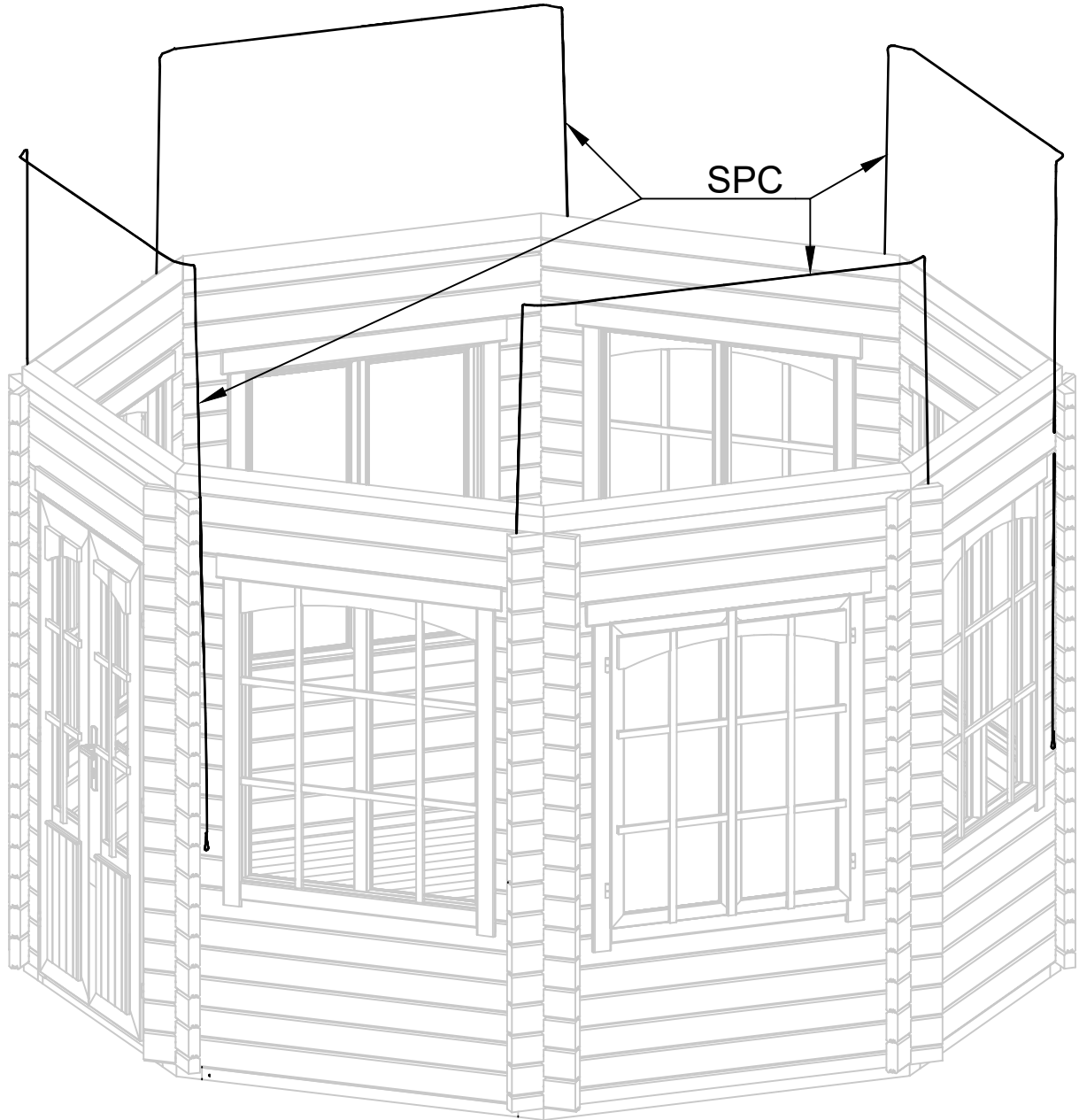

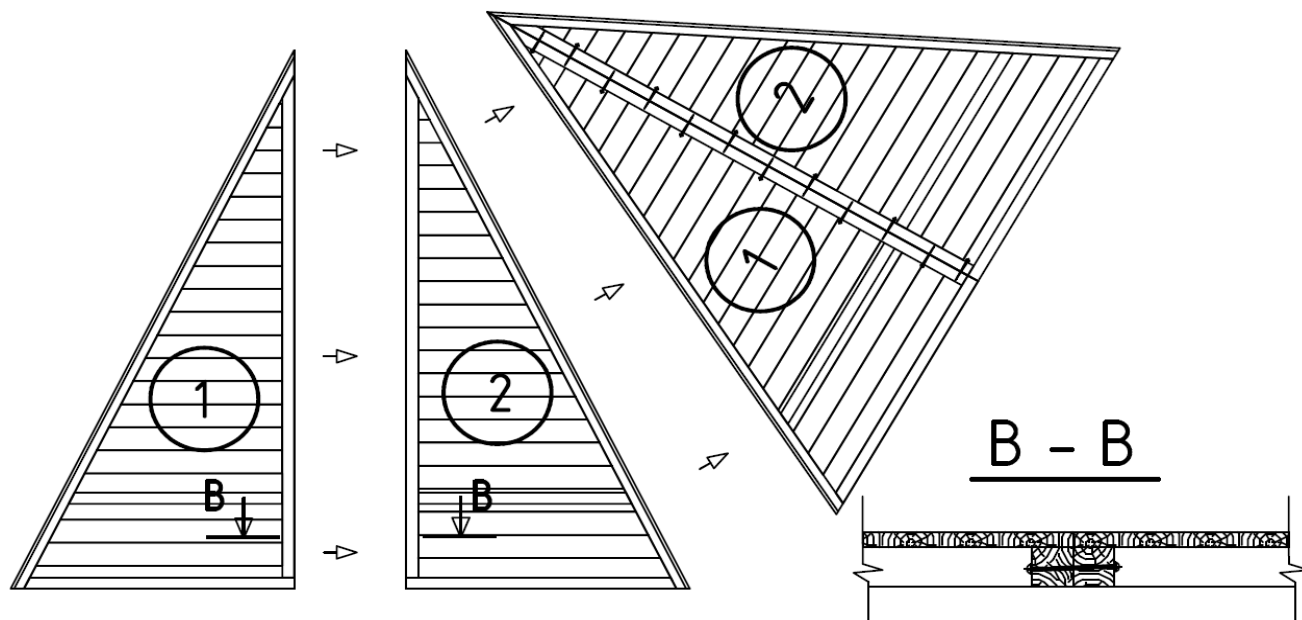

Attach left and right (1 & 2) roof panels together, using 2 screws HS1 (12 pcs total), at the lowest part (b-b), then at regular intervals using the remaining 10 screws, attaching them on alternating sides.

Verbinden sie die linke und rechte (1 & 2) dachfläche mit den schrauben HS1 (12 stück insgesamt) beginnend an der tiefsten stelle (bb). dann in regelmäßigen abständen die restlichen schrauben von beiden seiten bis hin zur spitze anbringen.

Assembler les panneaux de toit 1 et 2 avec les vis (HS1 - 12 vis au total) en les répartissant à intervalle régulier comme le montre le dessin ci-dessous.

Unire i pannelli del tetto 1 e 2 mediante le viti "HS1". Cominciate a fermare i pannelli con 2 viti e quindi finite di bloccarli con le restanti 10 ad intervalli regolari, come mostrato nella figura qui sotto (ne servono 12 in totale).

Voeg het linker- (1) en het rechterdakpaneel (2) samen. Gebruik 2 HS1 schroeven (12 stuks in totaal). Schroef deze 2 schroeven op de B-positie. Schroef vervolgens de overige 10 schroeven aan weerszijden vast.

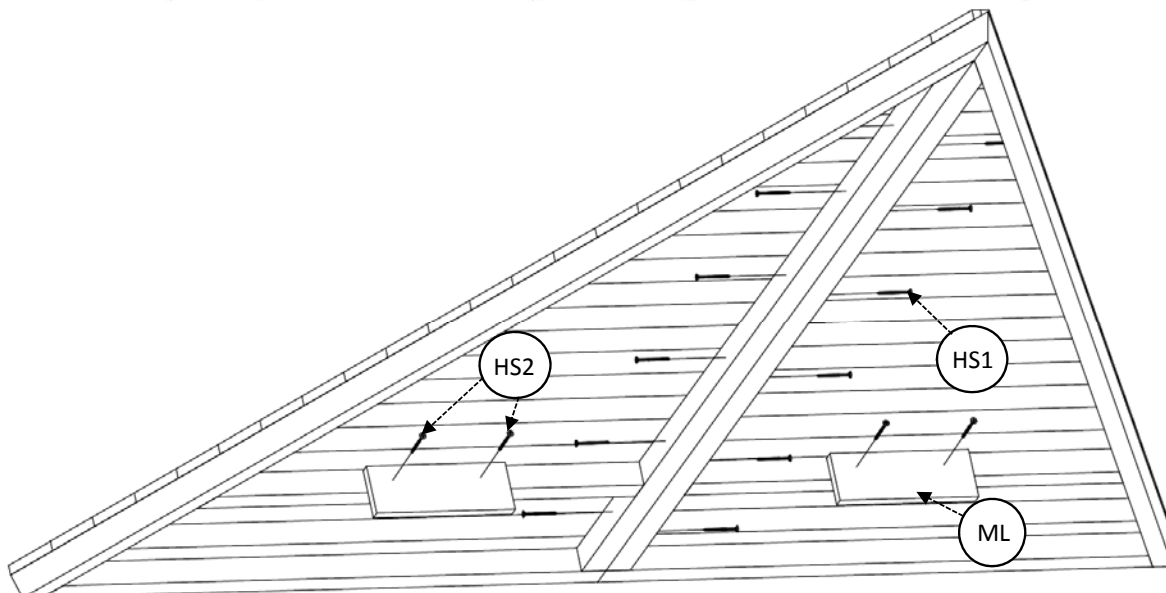

Using 2 screws (HS2) attach ML to the lower part cross batten on the underside of the roof panel (these are temporary supports).

Mit den zwei schrauben (HS2) befestigen sie die komponente ml auf dem unteren rahmenteil. Hierbei handelt es sich um stützen zur befestigung der dachflächen.

Pour la mise en place des panneaux de toit, veuillez visser temporairement les détails ml aux traverses intermédiaires avec les 2 vis (HS2) pour chaque détail ml. une fois la mise en place de la toiture terminée, vous pourrez les enlever.

Per posizionare i pannelli del tetto, fissate provvisoriamente gli elementi "ML" alle traverse intermedie usando n. 2 "HS2" viti cadauno. Terminato il montaggio del tetto potrete rimuovere gli elementi "ML"

Gebruik 2 schroeven (HS2) en schroef deze op positie ML op het onderste gedeelte vast op de onderkant van het dakpaneel. Dit is ter tijdelijke ondersteuning.

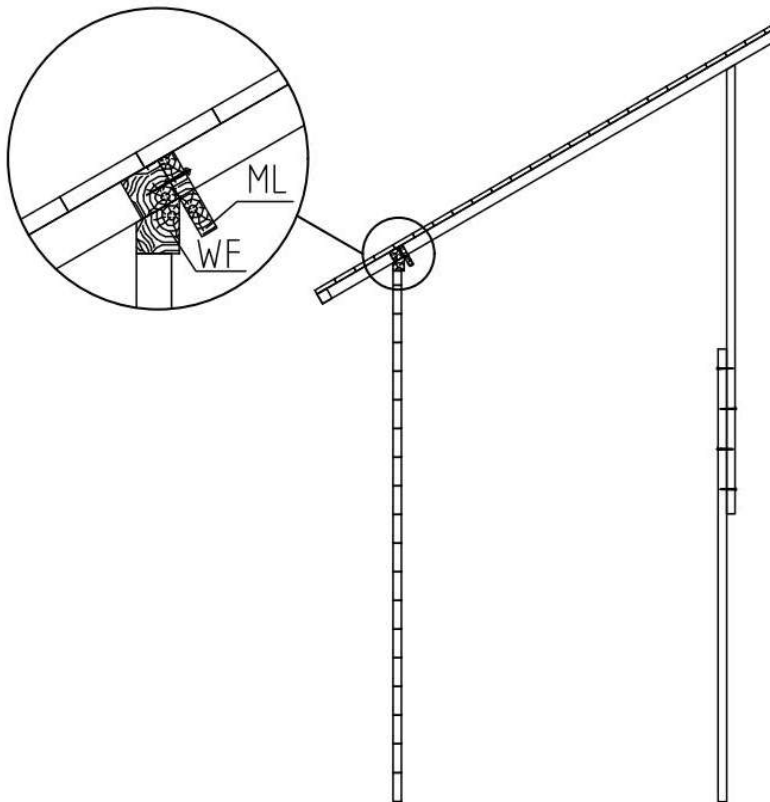

Attach together parts ab so that the entire length is 3230 mm using 4 screws provided HS3. This is a temporary support to help you mount the roof.

Verbinden sie die beiden komponenten a & b mittels der vier schrauben HS3 miteinander. So dass die länge 3.230 mm beträgt. Hierbei handelt es sich um eine temporäre stütze zur installation der dachflächen.

Pour la mise en place des panneaux de toit, veuillez visser avec 4 vis (HS3) les supports de maintien de toit ab ensemble de telle sorte à obtenir un poteau d'une hauteur totale de 3 230 mm. Une fois la mise en place de la toiture terminée, vous pourrez l'enlever.

Proseguite l'assemblaggio dei pannelli del tetto fissando con n 4 viti "HS3" i supporti provvisori di sostegno del tetto "AB" in modo da ottenere un palo alto cm 323, che vi aiuterà nel posizionamento degli stessi pannelli, dopo di che potrete smontarlo.

Voeg de onderdelen AB samen zodat de totale lengte 3230 mm is. Gebruik 4 schroeven (HS3). Dit is een tijdelijke bevestiging om je te helpen het dak te bevestigen.

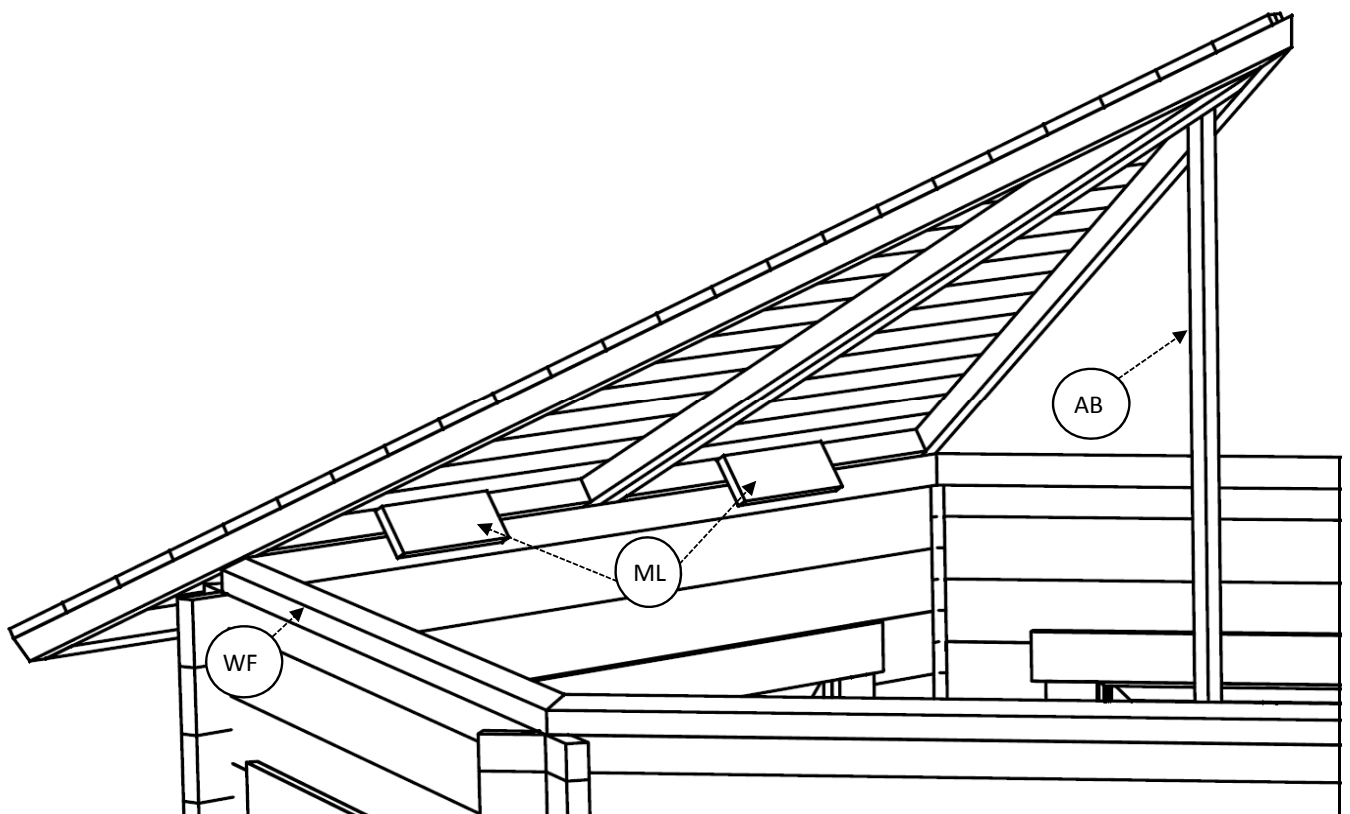

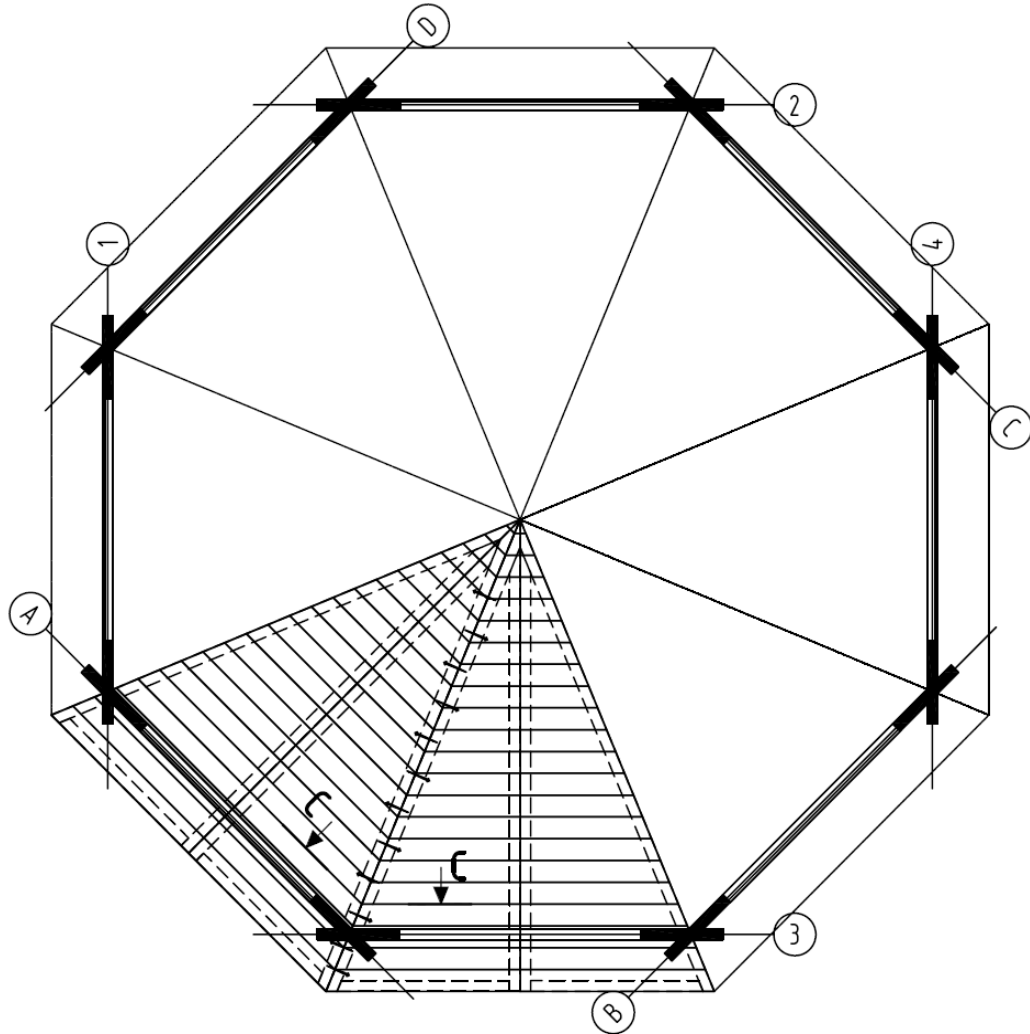

Mount the first roof section you have created next to the second one (c-c), (with the help of roof support ab) - making sure they are aligned and using screws HS1 (12 pcs) screw alternate sides all the way up, (do not tighten until all panels have been attached, you may need to adjust the positioning and height at the end). Once the correct positioning has been achieved tighten all screws.

Montieren sie nun nacheinander die einzelnen dachflächendreiecke unter zuhilfenahme der stütze ab. Verbinden sie die einzelnen dreiecke wieder mit den schrauben HS1 (12 st.) vom boden bis zur spitze. die schrauben bitte nicht sofort fest anziehen, so dass sie die dachelemente ggf. noch justiert werden können. nachdem alle dreiecke an seiner korrekten position sind und das dach justiert wurde, bitte die schrauben fest anziehen.

Placer sur le toit les éléments de toit préassemblés côte à côte (c - c) , en vous aidant du poteau de maintien de toit ab. Assurez-vous de leur bon alignement et visser les ensemble à intervalle régulier en utilisant les vis HS1 (12 vis pour fixer à chaque fois 2 panneaux). Attention, ne pas visser à fond tant que tous les panneaux ne sont pas mis en place, car vous aurez peut-être besoin d'ajuster le positionnement de certains d'entre eux. Une fois tous les panneaux de toit mis en place correctement, alors visser à fond.

Posizionate sul tetto le coppie di pannelli precedentemente avvitate (C-C) aiutandovi con il palo precedentemente assemblato "AB". Assicuratevi che siano ben allineate, quindi fissateli **SENZA AVVITARE A FONDO LE VITI** . Utilizzate n. 12 viti "HS1" ad intervalli regolari per ogni lato da unire. Controllate che le coppie dei pannelli siano posizionate perfettamente tra loro, **QUINDI AVVITATE A FONDO LE VITI** !

Bevestig de eerste dak sectie die je gemaakt hebt naast de 2e (C-C) met behulp van de dak ondersteuning (AB). Zorg dat de onderdelen evenredig verdeeld zijn en maak gebruik van de HS1 schroeven (12 stuks). Schroef de dak sectie afwisselend aan beide kanten naar boven toe vast. Doe dit niet te strak totdat alle secties bevestigd zijn. Aan het eind kun je dan nog de positie en de hoogte aanpassen. Als dit gedaan is wel de schroeven wel stevig aan draaien.

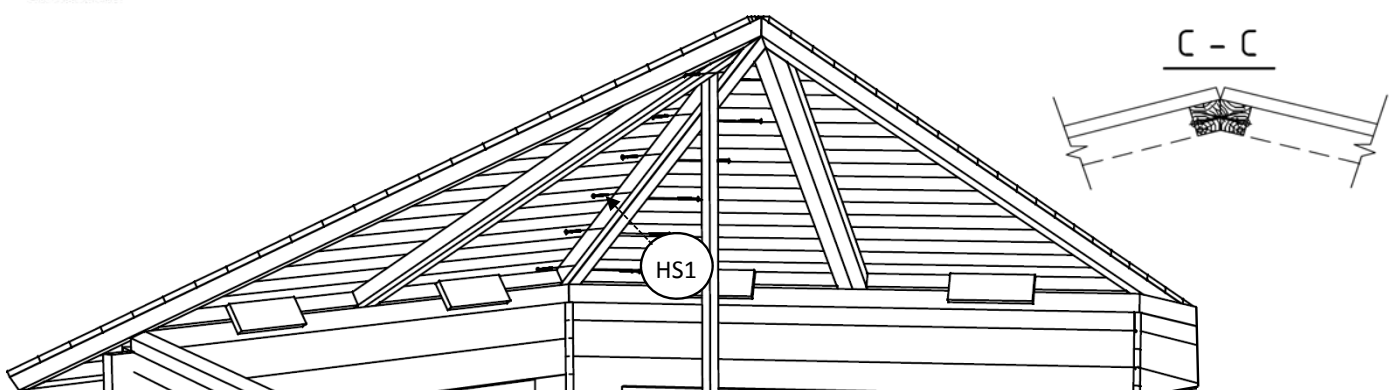

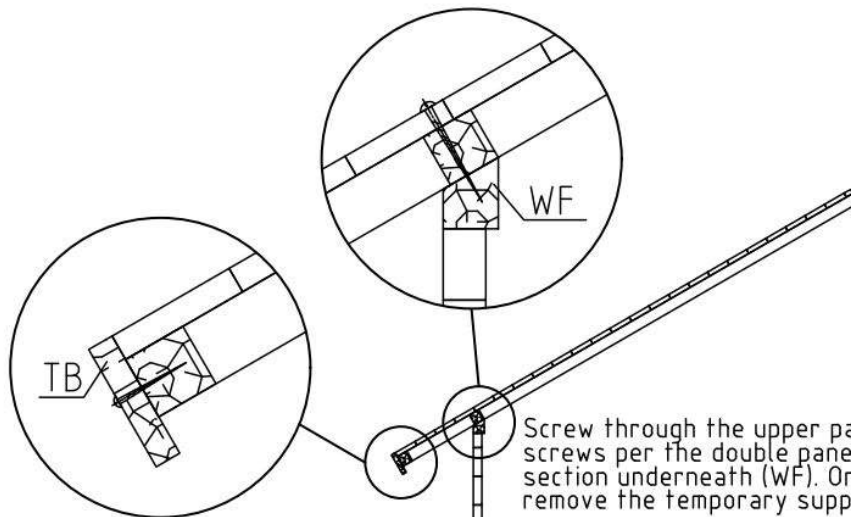

Under the eaves of the roof edge attach the fascia board TB using screws provided HS5 (3 pcs).

Anschließend bringen sie bitte die umlaufenden abschlußbretter (TB) mittels der drei schrauben HS5 jeweils am unteren rahmenteil der dachflächendreiecke an.

Fixer les planches de rives tb aux extrémités visibles des panneaux de toit avec les vis HS5 (3 vis par planche).

Fissate il massello di rifinitura "TB" in testa davanti l'estremità visibile dei pannelli del tetto usando le viti "HS5" nella quantità di n. 3 viti ogni lato.

Bevestig de gevellijst TB onder de dakrand met behulp van de HS5 schroeven (3 stuks).

Screw through the upper part of the roofing using HS4 screws (8 screws per the double panel section you created) into the wall section underneath (WF). Once this is complete you can then remove the temporary supports ml and HS3.

Schrauben sie nun durch die dachelemente (b/b, c/c etc.) die schrauben HS4 (8 schrauben je doppeldreieck) in die darunter liegende komponente WF um die dachflächen mit den wänden zu verbinden. Sobald dies abgeschlossen ist, können die temporären stützen ML und a/b entfernt werden.

Visser les panneaux de toit en place aux madriers supérieurs de finition (WF) en utilisant les vis HS4 (8 vis par panneaux préassemblés). Une fois terminée, vous pouvez enlever les supports ML de chaque panneau et le poteau de maintien de toit ab.

Avvitare il tetto da sopra utilizzando n. 6 viti "HS4" in ogni lato dell'esagono ottenuto, alla sommità delle pareti del gazebo. Terminata questa operazione potrete tranquillamente togliere gli elementi "ML" ed il palo di sostegno "MB" essendo divenuti ormai inutili.

Schroef door het bovenste gedeelte van het dak met de HS4 schroeven (6 schroeven per dubbele paneel sectie). Wanneer dit gedaan is kan de tijdelijke ondersteuning ML en HS3 verwijderd worden.

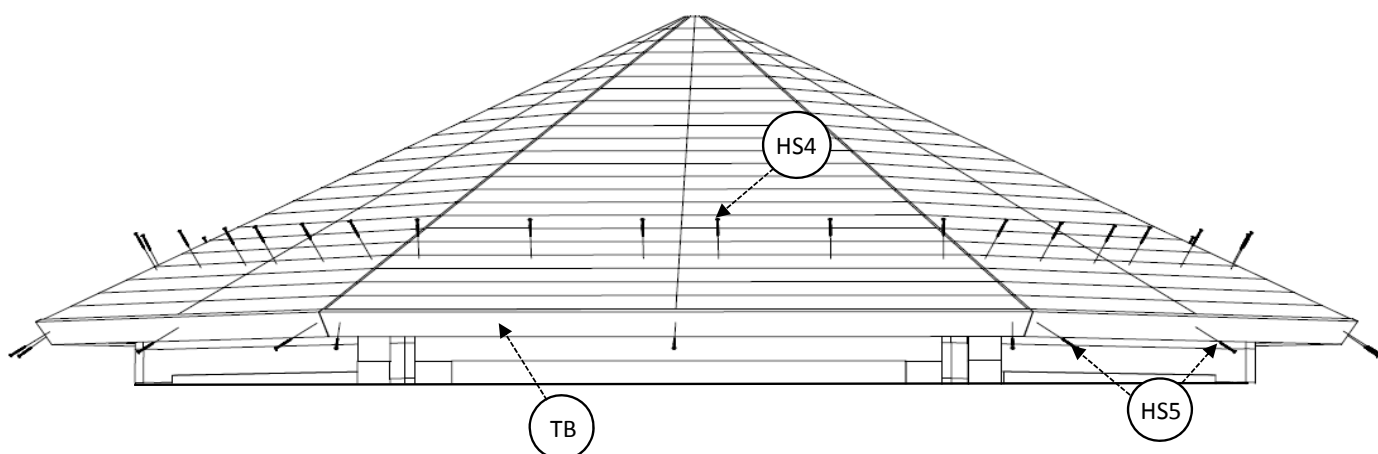





Then you are ready to apply shingles or felt (not supplied).





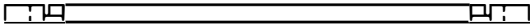
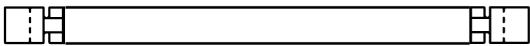
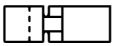

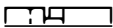
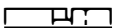
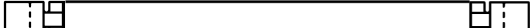
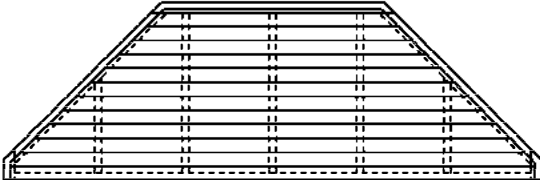
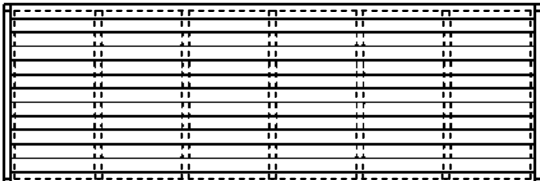
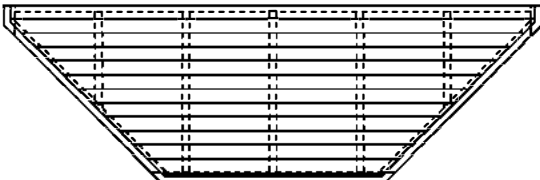
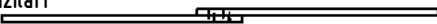

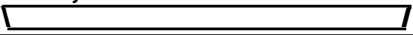
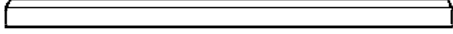
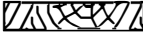
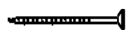

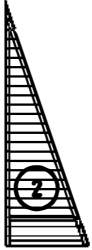



Nun können sie damit beginnen die dacheindeckung zu verlegen (nicht im lieferumfang enthalten).

Vous pouvez maintenant procéder à la mise en place de la finition de toiture (fournie séparément en option).





Adesso potete applicare sul tetto qualsiasi tipo di protezione e rifinitura abbiate deciso di acquistare.



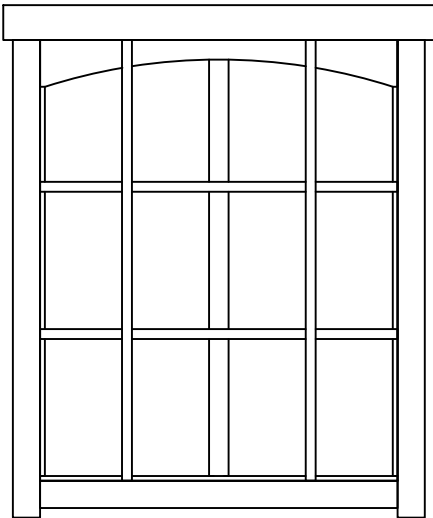
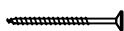

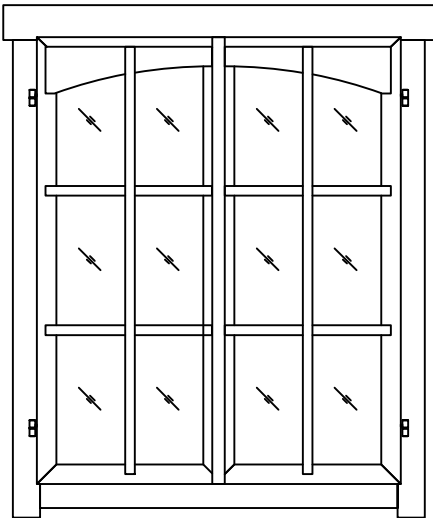
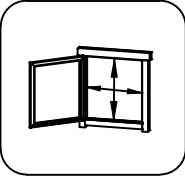

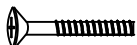
Hierna kan het asfaltpapier of de shingels gemonteerd worden.

Pos	06.04.2018 Piece list - Stückliste - Liste des pièces - Elementi - Stuklijst - Tükitalabel Art.Nr.PA165020	13/14	Q	P (mm)	L (mm)
001			3	44x57	1685
002			51	44x114	1685
003			93	44x114	340
004			93	44x114	340
005			4	44x57	1685
006			1	44x114	340
007			1	44x114	340
008			4	44x114	1685
K1	Floor element - Bodenelement - Plancher prémonté - Parti per pavimento - Vloer element - Põrandakilp 		1	63x3458x1170	
K2	Floor element - Bodenelement - Plancher prémonté - Parti per pavimento - Vloer element - Põrandakilp 		1	63x3458x1144	
K3	Floor element - Bodenelement - Plancher prémonté - Parti per pavimento - Vloer element - Põrandakilp 		1	63x3458x1170	
AB	Assembly batten - Montagelatte - Baguettes de maintien, nécessaires a la mise en place des panneaux de toit - Battente di montaggio - Montage lat - Montaažilatt 		2	28x34	1800
	Floor fillet - Fussbodenleiste - Corniere de finition du plancher - Finitura per pavimento (battisco pa) - Vloerafwerkljst - Põrandaliist 		2	18x18	6000
TB	Fascia board - Traufbrett - Bandeau de toit - Finitura lati tetto - Gevellijst - Räästalaud 		8	18x90	1635
WL	Wall finishing board - Abschlussbohle - Madrier supérieur de finition - Assi di finitura della parete - Wand afdekplaat - Kald-poollaud 		8	44x92	1436
ML	Assembly batten - Montagelatte - Baguettes de maintien, nécessaires a la mise en place des panneaux de toit - Battente di montaggio - Montage lat - Laud katusekilpide fikseerimiseks 		16	18x90	
	Screw for wall finishing board - Schraube für abschlussbohle - Vis d'assemblage des madriers supérieur de finition - Viti per bordo di finitura parete - Schroef voor afdekwandbalk - Kruvi ülemise vöö kinnitamiseks 		32	5x120	

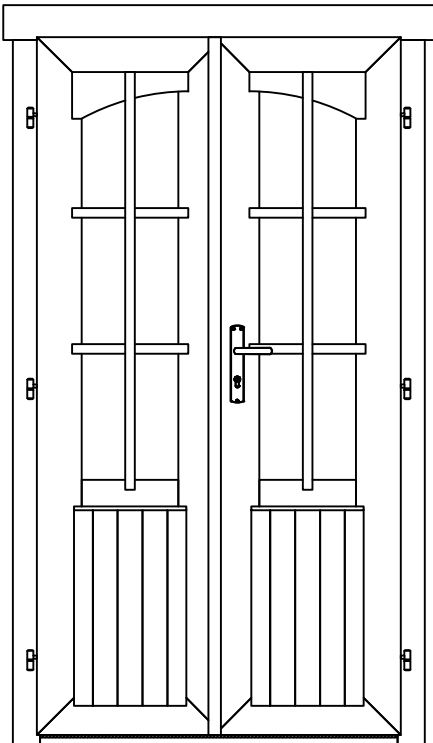
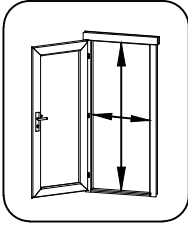
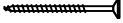
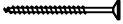
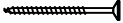
Pos	06.04.2018 Piece list - Stückliste - Liste des pièces - Elementi - Stuklijst - Tükítabel Art.Nr.PA165020	14/14	Q	P (mm)	L (mm)
	Roof element - Dachelement - Panneau de toit prémonté - Componente del tetto - Dakelement - Katusekilp		8	62x806x2348	
	Roof element - Dachelement - Panneau de toit prémonté - Componente del tetto - Dakelement - Katusekilp		8	62x806x2348	
SPC	Storm protection wire cables - Drahtseile für sturmsicherung - Cables metallique anti-tempete - Cavi di protezione antivento - Storm beveiliging draadkabels - Tormikinnitustross		4		6100
HS1	Screw for fixing roof elements - Schraube für befestigung - dachelementen - Vis de fixation des panneaux de toit - Vite per fissare gli elementi del tetto - Schroef voor bevestiging dakelement - Kruvi kilpide montaažiks		192	4.5x80	
HS2	Screw for assembly batten - Schrauben für montagelatte - Vis de fixation des baguettes de maintien pour mise en place du toit - Viti per assemblaggio stecca - Schroef voor montage lat - Kruvi katusekilpide fikseerimiseks		32	4x40	
HS5	Screw for fascia boards - Schrauben für traufbretter - Vis pour fixation bandeau de toit - Viti x striscia del tetto - Schroef voor gevellijst - Kruvi räästalaual		24	4x40	
HS3	Screw for assembly batten - Schrauben für montagelatte - Vis de fixation des baguettes de maintien pour mise en place du toit - Viti per assemblaggio stecca - Schroef voor montage lat - Kruvi montaažilatile		4	4x60	
	Screw for 1. wall beam - Schraube für 1. bohlenreihe - Vis de fixations 1ere rangée de madriers avec poutrelles de fondations - Vite fissaggio alle fondamenta - Schroef voor 1 wandbalk - Kruvi poollauale		10	5x90	
	Screw for foundation - Schrauben zur befestigung fundament - Vis de fixations des poutrelles de fondations - Viti x fondamenta - Schroef voor fundering - Kruvi alusraamile		12	5x90	
HS4	Screw for fixing roof elements - Schraube für befestigung dachelementen - Vis de fixation des panneaux de toit - Vite per fissare gli elementi del tetto - Schroef voor bevestiging dakelement - Kruvi kilpide kinnitamiseks seinaga		48	5x90	
	Zn nail for floor fillet - Zn nagel für fussbodenleiste - Pointe pour corniere de finition du plancher - Chiodi x fissaggio pavimento - Spijker(nagel) voor vloer afdeklijst - Nael põrandaliistule		24	1.4x40	
SH44	Hammer block - Schlagholz - Calle de frappe - Blocco di legno da usare come cuscinetto quando si usa il martello - Slagklos - Löögiklots		1		
CSP	Clamps for storm protection - Klemmen für sturmsicherung - Collier pour lame anti-tempete - Morsetti per protezione contro il temporale con vento - Stormanker lat klem - Tormikinnitustrossi lukk		16		
TSP	Turnbuckles for storm protection - Spannschlösser für sturmsicherung - Tendeur a vis pour lame anti-tempete - Tiranti per la protezione dalle tempeste - Spanners voor stormbescherming - Tormikinnitustrossi pinguti		4	D6	
SSP	Screw-eyelets for storm protection - Schraubösen für sturmsicherung - Oeillets de vissage pour lame anti-tempete - Vite per fissaggio protezione antivento - Hijsogen voor stormzekering - Tormikinnitustrossi silmuskruvi		8		
	Window - Fenster - Fenetre - Finestra - Raam - Aken 996x1210 TAK.1.106.TSM0.Ke SGC+A		4		
	Window - Fenster - Fenetre - Finestra - Raam - Aken 996x1210 TAK.1.106.TSVP.Ke SGC+A		3		
	Door - Tür - Porte - Porte - Deur - Uks 996x1850 TUK.2.066.TSVP.MMWKd SGC+0A		1		

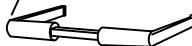
Pos	07.12.2017 Piece list - Stückliste - Liste des pièces - Elementi - Stuklijst - Tükítabel 996x1210 TAK.1.106.TSM0.Ke SGC+A	1/1	Q	P (mm)	L (mm)
<p data-bbox="256 152 1289 183">Glass size - Glasgröße - Taille de la vitre - Misura del vetro - Glas afmeting - Klaasi mõõt: 443x1130 mm</p> 					
HS1	<p data-bbox="256 2116 1109 2199">Screw for georgian bars - Schraube für sprossen - Vis pour croisillons - Viti per unire la griglia georgiana della finestra - Schroeven voor raamverdeling - Kruvi akna petfeliistule</p>		12	2.5x20	

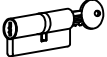
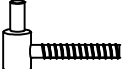
Pos	04.12.2017 Piece list - Stückliste - Liste des pièces - Elementi - Stuklijst - Tükitalabel 996x1210 TAK.1.106.TSVP.Ke SGC+A	1/1	Q	P (mm)	L (mm)
<p>Glass size - Glasgröße - Taille de la vitre - Misura del vetro - Glas afmeting - Klaasi mõõt: 394x1066 mm</p>   <p>896x1110 mm</p>					
FS1	Window handle fittings - Fenstergriff - Poignee de fenetre - Maniglia c/ferramenta - Raamhendel -/grendel -/klink - Aknalink		1		
FSP	Bolt for window handle fittings - Bolzen für fenstergriff beschlag - Vis pour fixation poignee de fenetre - Bullone x apertura manuale finestra - Schroef voor raamhendel - Akna käepideme polt		2		
HS1	Screw for georgian bars - Schraube für sprossen - Vis pour croisillons - Viti per unire la griglia georgiana della finestra - Schroeven voor raamverdeling - Kruvi akna petteliistule		20	2.5x20	
HS4	Screw for window fillet - Schraube für glasteiste - Vis de filet de fenetre - Vite per assemblaggio finestra - Schroef voor glaslijst - Kruvi akna kokkuvaltšiliistule		3	3x30	

Pos	05.12.2017	Piece list - Stückliste - Liste des pièces - Elementi - Stuklijst - Tükitalabel 996x1850 TUK.2.066.TSVP.MMWkd SGC+0A	1/1	Q	P (mm)	L (mm)
		Glass size - Glasgröße - Taille de la vitre - Misura del vetro - Glas afmeting - Klaasi mõõt: 265x1041 mm				
		  <p>896x1768 mm</p>				
HS1	Screw for georgian bars - Schraube für sprossen - Vis pour croisillons - Viti per unire la griglia georgiana della finestra - Schroeven voor raamverdeling - Kruvi ukse peffeliistule		20	2.5x20		
HS4	Screw for door fillet - Schraube zur befestigung türleiste - Vis pour fixation baguette d'arret de porte - Viti per massellino della porta - Schroef voor deurlijst - Kruvi ukse kokkuvaltssiliistule		5	3x30		
HS16	Screw for door jamb - Schraube für türrahmen - Vis de fixation partie haute avec montants du cadre de porte - Viti x fissaggio montanti porte - Schroef voor deurkozijn - Kruvi ukse lengile		4	5x90		
HS25	Screw for doorstep - Schrauben für swelle - Vis pour fixation barre de seuil - Vite per soglia della porta - Schroef voor deurdorpel - Kruvi lävepakule		3	4.5x65		
TL4	Door handle fittings - Türgriff - Poignee de porte - Maniglie - Deurhendel / klink - Ukse käepide VU		1			
TL5	Set of door lock covers - Schlossblenden - Set de garnitures de porte - Copertura serrature - Slot sluitplaat set - Ukse lukuplaat		1			
	Cylinder lock - Zylinderschloss - Barillet de porte - Serratura - Cylinder slot - Ukse lukusüdamik		1	30x35		
	Male bolt hinge for door - Türband - Partie male de paumelle de porte - Cerniera anube x porta - Scharnier bout - Ukse polthing isane		6			
	Striker for barrel bolt - Hülse für grendelriegel - Gache au sol du targette - Boccola per fermo della porta - Huls voor vergrendelingsschuif - Vasturaud ukse servariivile		2			