

## CURT CUCUMBER Manual

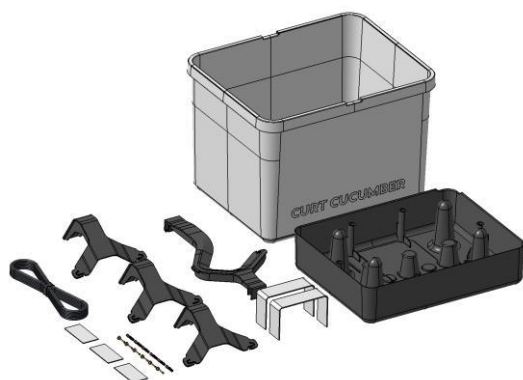

### Package contents:

- 1x planter
- 1x water tank
- 1x stabilizer
- 2x irrigation wicks
- 3x wall mount
- 3x adhesive tapes
- 6x screws
- 6x dowels

### Step 1:

Lead the irrigation wicks through the openings in the bottom of the planter.



### Step 2:

Place the planter onto the water tank.

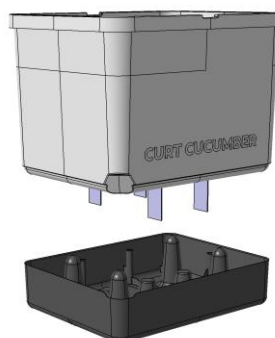

### Step 4:

Put the stabilizer for the climbing support in the middle of the planter.

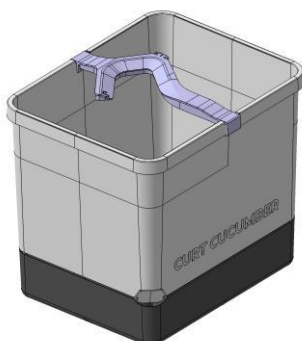

### Step 5 (option 1):

Fix the double faces adhesive tapes with the wall mounts on a wall or window. Mind a gap about 1 m between.

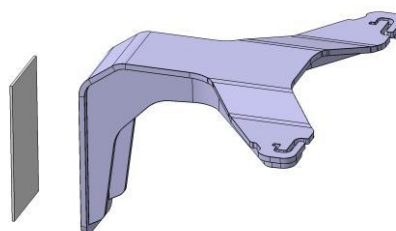

**Step 6 (option 2):**

Fix one wall mount with 2 dowels and 2 screws.

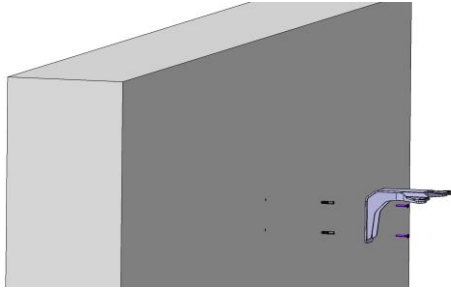

**Step 7 (option 2):**

Repeat the last step for the other 2 wall mounts. Mind a gap about 1m between and place the planter underneath.

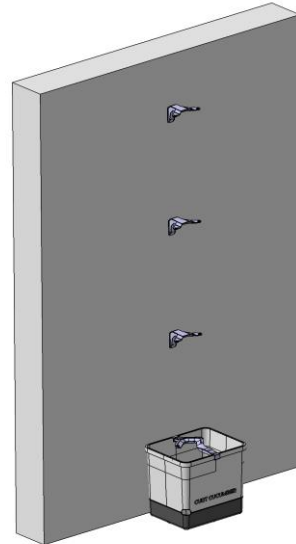

**Step 8:**

Lead the cord through the wall mounts and fix it to the stabilizer in the planter.

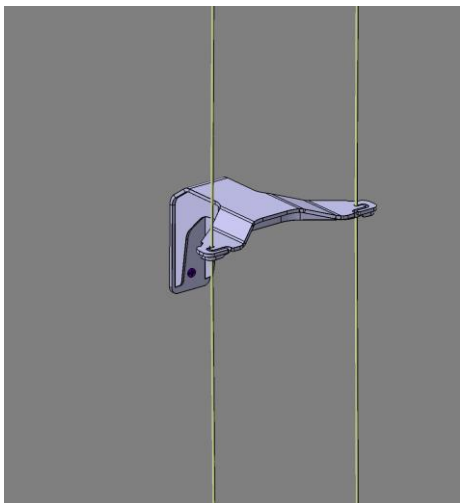

**Step 9:**

Fill the planter with soil and plant one seedling in it.