

DANCOVER[®]

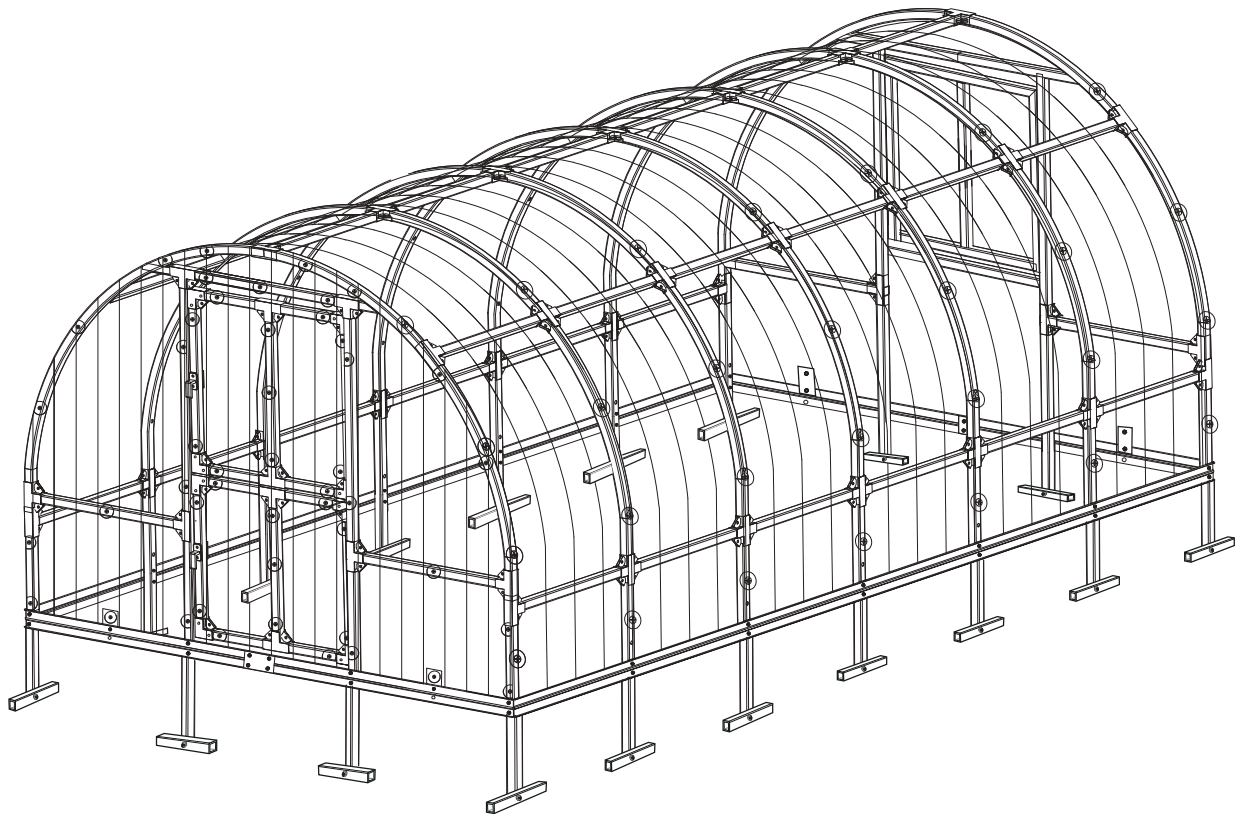

Manual
for
Greenhouse TITAN Arch+ 320



Dear Customers,

Having decided to buy a greenhouse, you have received a product made with the utmost care the frame of which is made of tubular metal profiles 20 x 20 mm and extremely strong.

Simple construction makes the greenhouse easy to assemble.

An abundance of accessories will give you the freedom to implement your ideas.

ATTENTION!

Always wear protective work clothing and protective equipment when assembling the greenhouse frame and working with the canal-type polycarbonate cover!

For greenhouse assembly you will need the following tools:

- 8 mm diameter hexagon wrench or an open-end wrench.
- Screwdriver with cross-head end or cordless screwdriver.
- A shovel for digging pits.
- A spirit-level to measure the level.
- A rope for measuring diagonal.
- A knife (or a cutter with breakable blades) for cutting polycarbonate sheets.

Follow local construction instructions, if necessary.

In case of strong wind or storm, windows or doors **MUST BE CLOSED!**

IN CASE OF "LIGHT" SOIL, WE RECOMMEND THAT THE GREENHOUSE WOULD BE ADDITIONALLY ANCHORED TO THE GROUND.

Before starting to assemble the greenhouse, you should read the entire manual at least once and familiarize yourself with individual sections and profiles. This is an important aid to you.

Check the delivery contents by the specification of parts. **IF YOU FIND DISCREPANCIES WITH THE SPECIFICATION, CONTACT THE SELLER IMMEDIATELY AND REPORT ABOUT THE SHORTAGE OF THE PARTS**

When assembling a greenhouse, we recommend that you first tighten the screws by hand insecurely so that the profiles can be moved freely when needed.

Level the assembled greenhouse frame with a spirit-level and then tighten the screws.

We reserve the right to make technically advanced changes and improvements, therefore, discrepancies in description and illustration may occur.

We wish you much happiness and success in purchasing our greenhouse.

***ATTENTION! Do not use sulphur chimney boxes for disinfection of the greenhouse!
During the chemical reaction, the metal is covered with white powder!***

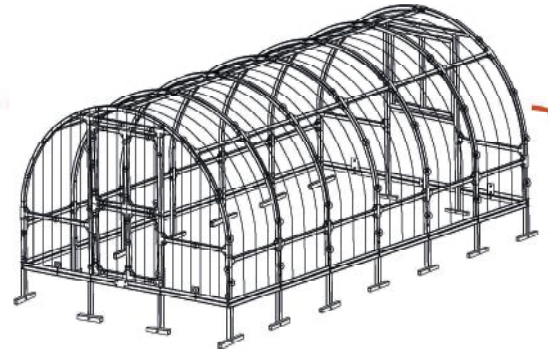

Installation instruction **PARTS LIST**









Greenhouse base pack

* THE NUMBER OF BOXES DEPENDS ON THE PURCHASED M² SIZE GREENHOUSE!

* Greenhouse area		6m ²	12m ²	18m ²	24m ²	30m ²	36m ²
Box 1/4	BASE Profiles packaging	1	1	1	1	1	1
Box 2/4	BASE Packaging of archs	1	1	1	1	1	1
Box 3/4	BASE Accessories packaging	1	1	1	1	1	1
Box 4/4	BASE Polycarbonate packaging	1	1	1	1	1	1
Box 1/4	EXTENSION Profiles packaging	—	—	1	2	3	4
Box 2/4	EXTENSION Packaging of archs	—	—	1	2	3	4
Box 3/4	EXTENSION Accessories packaging	—	—	1	2	3	4
Box 4/4	EXTENSION Polycarbonate packaging	—	—	1	2	3	4
TOTAL PACKAGING		4	4	8	12	16	20

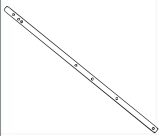
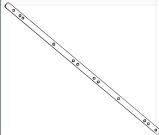



TITAN Arch+ 320

Table NO.1

NR.	Name	Length (mm)	Photo	Box 1/4		Box 1/4
				BASE Profiles packaging		EXTENSION Profiles packaging
				Greenhouse area		2m EXTENSION
				6m ²	12m ²	
2220x100x150mm 35kg		2220x100x200mm 45kg	2100x100x80mm 12kg			
Number in package (pcs.)						
NR. 5	Lateral lower arch stud (left, right)	940		4	10	6
NR. 6	Lateral lower arch stud (left, right) with more holes	940		4	4	—
NR. 7	Fasteners to the ground	200		12	18	6
NR. 8	Arch fastening - crossbars	2000		4	8	4
NR. 9	Arch fastening -crossbars (top, centre)	643		3	6	3
NR. 10	Stilt of the door -window	2210		2	2	—
NR. 11	Stilt of the door -window with more holes	2210		2	2	—
NR. 12	Side reinforcements of the front-rear part	970		4	4	—
NR. 13	Transvere stand of doors-windows (with cut ends at 45°)	1320		2	2	—
NR. 14	Transverse fastening under the window (rear of the greenhouse)	965		1	1	—

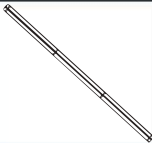
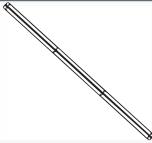
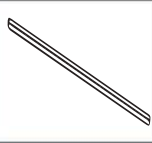
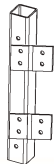
TITAN Arch+ 320

Table NO.1

NR.	Name	Length (mm)	Photo	Box 1/4		Box 1/4
				BASE Profiles packaging		EXTENSION Profiles packaging
				Greenhouse area		2m EXTENSION
				6m ²	12m ²	
				2220x100x150mm 35kg	2220x100x200mm 45kg	2100x100x80mm 12kg
Number in package (pcs.)						
NR. 15	Sides of foundation base	1990		—	2	2
NR. 16	Sides of foundation base	2010		2	2	—
NR. 17	Front, rear parts of foundation base	1515		4	4	—
DOOR-WINDOW						
DOOR NR.1	Part of the door whit loop	885		3	3	—
DOOR NR.2	Part of the door wiht handle	885		3	3	—
DOOR NR.3	Bottom/top part of the door (horizontal part)	950		6	6	—
DOOR NR.4	Transverse part of the door (vertical parts)	885		3	3	—

TITAN Arch+ 320

Table NO.2













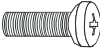

NR.	Name	Length (mm)	Photo	Box 2/4		Box 2/4
				BASE Packaging of archs		EXTENSION Packaging of archs
				Greenhouse area		2m EXTENSION
				6m ²	12m ²	
				2200x600x50mm 17kg	2200x600x50mm 27kg	2100x450x20mm 12kg
Number in package (pcs.)						
NR. 1	Arch (top, centre)	2280		2	5	3
NR. 2	Arch (top, centre) with more holes	2280		2	2	—
NR. 3	Arch lateral (left, right)	1210		4	10	6
NR. 4	Arch lateral (left, right) with more holes	1210		4	4	—

Table NO.3

NR.	Name	Length (mm)	Photo	Box 3/4		Box 3/4
				BASE Accessories packaging		EXTENSION Accessories packaging
				Greenhouse area		2m EXTENSION
				6m ²	12m ²	
				410x220x190mm 5,3kg	410x220x190mm 5,5kg	160x160x150mm 3,5kg
Skaičius pakuotėje (vnt.)/ Numurs iepakojumā (gab.)/ Number in package (pcs.)						
NR. 18	Angles of the foundation	80x90		4	4	—
NR. 19	Plates for linking the foundation			4	8	4

TITAN Arch+ 320

Table NO.3

NR.	Name	Length (mm)	Photo	Box 3/4		Box 3/4
				BASE		EXTENSION
				Accessories packaging		Accessories packaging
				Greenhouse area		2m EXTENSION
6m ²	12m ²					
				410x220x190mm 5,3kg	410x220x190mm 5,5kg	160x160x150mm 3,5kg
Number in package (pcs.)						
NR. 20	Srews M5-16	I-16		132	192	60
NR. 21	Srews M5-40	I-40		196	236	36
NR. 22	Srews M5-45	I-45		12	18	6
NR. 23	Srews M4-45	I-45		6	6	—
NR. 24	Self-tapping screws	4,2x190		4	4	—
NR. 25	Nuts M5			340	446	102
NR. 26	Nuts M4			6	6	—
NR. 27	Interim transparent			68	92	24
NR. 28	Interim transparent (half)			56	56	—
NR. 29	Handle set with screws			3	3	—

TITAN Arch+ 320

Table NO.3









NR.	Name	Length (mm)	Photo	Box 3/4		Box 3/4
				BASE		EXTENSION
				Accessories packaging		Accessories packaging
				Greenhousearea		2m EXTENSION
6m ²	12m ²					
				410x220x190mm 5,3kg	410x220x190mm 5,5kg	160x160x150mm 3,5kg
Number in package (pcs.)						
NR. 30	Forked-type connection			24	24	—
NR. 31	T-piece connection			52	52	—
NR. 32	Four-branch connection			20	50	30
NR. 33	Polycarbonate attachment plates			5	5	—
NR. 34	Protective sealing tape for slabs	rul		1	1	—
NR. 35	S-shaped loop			2	2	—
NR. 36	Eyebolt			4	4	—
NR. 37	Chain			2	2	—

Table NO.4

Name	Length (mm)	Photo	Box 4/4		Box 4/4	
			BASE		EXTENSION	
			Polycarbonate packaging		Polycarbonate packaging	
			Greenhousearea		2m EXTENSION	
6m ²	12m ²					
				2100x700x700mm 8,19kg	2100x700x700mm 24,57kg	2100x600x600mm 8,19kg
Number in package (pcs.)						
Polycarbonate	2100 x 6000 mm		1	2	1	

Polycarbonate cutting scheme

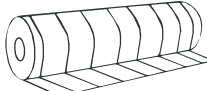

Do not mistake polycarbonate sides! Attach the side containing a UV protective layer outwards. The UV protective layer is covered with a film with inscriptions and the other side (to be covered inside) is covered with a transparent film. If necessary, it is recommended to cut the sheets with an electric circular saw, a manual saw with small teeth, a sharp knife. Be sure to tear off the films before installation! WEAR GLOVES WHEN CUTTING!

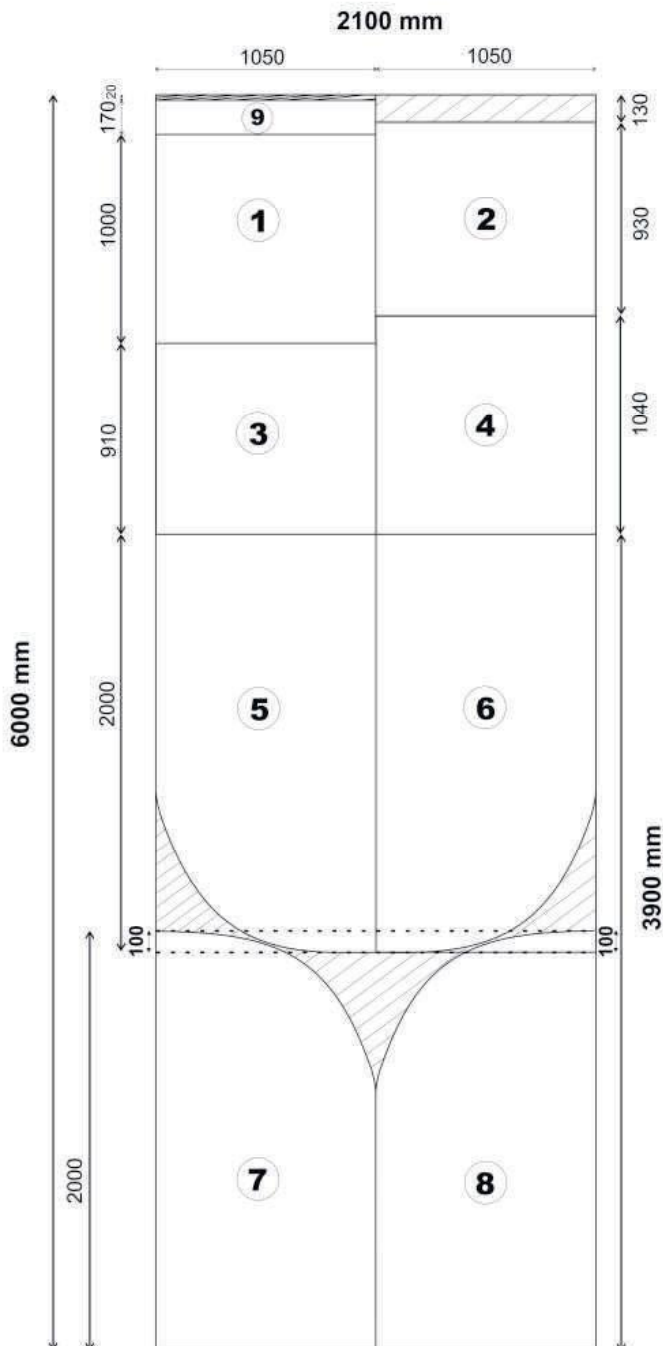

- 1- The upper part of the door
- 2- The bottom part of the door
- 3- The bottom of the window
- 4- Window
- 5- -6- -7- -8- Side parts
- 9- Top door - window polycarbonate

NOTES:

If you received sheets of 2100 x 6000mm, the top door window polycarbonate (1050x170 is mounted additionally) - 1 pc.

If you received sheets of 1050 x 2000mm, the top door window polycarbonate (1050x170 is mounted additionally) - 2 pc.t

If you received large sheets of 2.10x6.00m and additional ones of 1.05x2.00m, you do not need to cut large sheets according to the given scheme.

Large sheets of 2100x6000mm are used for the roof and 1050x2000mm for the ends, doors, and windows.

Follow the dimensions given in the table of polycarbonate dimensions.

Installation procedure

Prepare and level the greenhouse installation site according to the dimensions of the greenhouse purchased.

The installation instructions will describe how to install a 4 m long TITAN Arch+ 320 greenhouse. In this case, we present a scheme for digging or drilling holes in the ground at the edges of a prepared rectangle along the entire perimeter of a greenhouse with dimensions of ~ 25 cm in diameter, ~40 cm in depth.

1. Disassemble the received metal profile packages; check the contents, quantity, and length of the received parts with a list of parts. Separate and comfortably lay out the individual parts.

ATTENTION! The components of the arch are different! The arch parts that have more mounting holes are used to form the front and back arches of the greenhouse.

2. For assembling the foundation base, we use the front and rear parts of the foundation base (1515 mm long, No 17) and the lateral parts of the foundation base (2010 mm No 16 and 1990 mm No 15), foundation corners (No18), plates (No19) and bolts with nuts.

A) Join the front parts of the foundation base (1515mm No 17 + 1515mm long No 17) with plates (No19) on both sides, and secure with M5-16 bolts and nuts. The same action is performed with a rear part. **SEE Fig. 1**

B) Connect the lateral parts of the foundation base (2010 mm No 16 and 1990 mm No 15 long) with the plates (No19) on both sides and secure with bolts M5-40, M5-16, and nuts. The same action is performed with both side parts.

NOTE: For additional connection of the side parts, we use the bottom arch studs (940mm long, No5), with the anchors already inserted into the ground (200mm long, No 7) (SEE Fig. 2), which we attach to the side foundation base through the foundation connection plate with M5-40 bolts and M5 nuts. Use two bolts for all three parts, and where the plates are attached directly to the foundation, use bolts M5-16 with nuts. SEE Fig. 3.

C) Assemble all of these connected parts into a rectangle using the foundation base corners (No 18) by screwing with bolts M5-40, M5-16 and nuts. **SEE Fig. 4.**

Note: For additional connection of corners, we use lateral bottom arch studs containing the maximum number of holes (940mm long, No 6) with the anchors already inserted into the ground (200mm long, No 7) (SEE Fig. 2), which are attached to the side foundation through the narrow corner of the foundation base with bolts M5-40 and nuts M5. Two bolts are used for all three parts. The same action is performed in the remaining three corners.

For a greenhouse of 6 m in length, the foundation base shall be connected as follows: 2010 mm (No 16) + 1990 mm (No 15) + 1990 mm (No 15). The parts shall be connected in the same manner as described in the second clause of part C.

For a greenhouse of 8 m in length, the foundation base shall be connected as follows: 2010 mm (No 16) + 1990 mm (No 15) + 1990 mm (No 15). The parts shall be connected in the same manner as described in the second clause of part C, etc.

3. Measure the diagonal of the foundation base. The diagonal lengths should be equal. If the diagonal matches, tighten the foundation base screws all the way. **SEE Fig. 5.**

4. Fix the polycarbonate mounting plates (No.33) to the top of the front and rear foundation base parts using bolts M5-16 and nuts. Two plates shall be mounted on the front, three plates on the rear part. **SEE Fig. 6. NOTE: If purchased with an additional door, the panel is not mounted in the centre at the rear part of the panel.**

5. Fix the fastening elements to the ground (200mm long, No. 7) to the rest of the unused side bottom arch studs (940mm long, No.5) using M5-45 bolts and M5 nuts. **SEE Fig. 2**

Attach the prepared bottom studs to the sides of the foundation base at a distance of 643 mm between the arches at the indicated mounting points. The distances between the arches must be equal. You can use the upper crossbar arch fastening (643mm long, No 9) to check the distance.

6. Before installing the crossbar stud fastenings (2000 mm long, No 8), we recommend pre-assembling the T-piece (No 31) and four-branch unit (No 32) by completing them with bolts M5-16 and nuts.

7. Insert the four-branch units in the centre and the T-piece for the front and rear arches on all arch fastening crossbars (2000mm long, No 8).

8. Attach the prepared arch crossbar fastening (No 8) on the assembled bottom arch studs mounted onto the foundation using pre-assembled T-piece and four-branch unit by tightening them with M5-16 bolts and nuts. The distances between the arches must be equal. You can use the upper crossbar arch fastening (643mm long, No 9) to check the distance. Perform the same action on both sides. **SEE Fig. 7.**
NOTE: Leave the tops of the T-pieces and four-branch units loose, do not tighten firmly.

9. Insert the side arches (1210mm for inner arches (No 3) and 1210mm long with more mounting holes (No 4) for the side arches) into the existing free top parts of T-pieces and four-branch units, and tighten them.
The distances between the arches must be equal. You can use the upper crossbar arch fastening (643mm long, No 9) to check the distance. Perform the same action on both sides. **SEE Fig. 8 (A).** **NOTE: Use 1210mm parts with more mounting holes for the front and back arch of the greenhouse.**

10. Attach the prepared arch crossbar fastening to the top of the last secured arch (1210mm long, No. 4) using pre-assembled T-pieces and four-branch units by tightening them with M5 -16 bolts and nuts. The distances between the arches must be equal. You can use the upper crossbar arch fastening (643mm long, No 9) to check the distance. Perform the same action on both sides.
NOTE: Leave the tops of the T-pieces and four-branch units loose, do not tighten firmly.
SEE Fig. 8 (B)

11. Insert the upper arches (2280mm long (No 1) and 2280mm long (No 2) with more mounting holes) into the existing free top parts of T-pieces and four-branch units, and tighten them.
This is the last part of the arch and it is inserted into the free top parts of T-pieces and four-branch units located on both sides. The distances between the arches must be equal. You can use the upper crossbar arch fastening (643mm long, No 9) to check the distance. **NOTE: Use the 2280mm parts (No 2) with more mounting holes for the first and last arches of the greenhouse. SEE Fig. 8©**

12. Attach the upper crossbar arch fastening (643mm long, No 9) to the top arch already attached using the four-branch units and T-pieces and the M5-16 bolts with nuts. Use T-pieces for the front and rear arches and four-branch units for the rest. We recommend that you first attach on the front and rear part to ensure that the parts are evenly mounted. Visually align the profiles at the centre of the greenhouse and tighten them. We recommend stretching the tension rope to determine the alignment. **SEE Fig. 9**

13. Slide two pre-prepared T-pieces onto each of the door crossbar studs (1320mm long, No 13). Fix the prepared door-window crossbar stud to the front and rear arches using self-tapping screws (4.2x19mm) in specially designated point. **SEE Fig. 10**

14. Attach the fasteners to the ground (200mm long) on the door window crossbar studs 2210mm long (No10.11), using bolts M5-40 and nuts. **SEE Fig. 2**

15. Attach the door-window 2210 mm (No 10) and 2210 mm (No 11) long stud with more mounting holes on the tees on the door-window crossbar stud. Attach them to the top of the T-piece using bolts M5-

16 with nuts, and to the foundation base using bolts M5-40 and nuts. Do the same for the rear part of the greenhouse. **SEE Fig. 11. Note: There are two types of door studs: with more holes ready for door mounting and without them. Before installing the door studs, decide which side the door will open on. If you open the door with your right hand to the right when standing in front of the greenhouse (right door), then install the door stud with more mounting holes on the right.**

16. Attach the front-rear side fasteners (970 mm long, No 12) to the front-rear door window studs. Both ends of the front-rear side fastening profile are secured with T-pieces and bolts M5-16 with nuts. Attach from the top of the foundation at a height of 74 cm. **SEE Fig. 2.** The actions are repeated symmetrically in the front and rear part of the greenhouse. The distance between the door studs at the top and bottom should be 965mm. Attach the 960mm long stud fastener (No14) at the rear part of the greenhouse, at the bottom of the door, 900mm from the top of the foundation. **SEE Figure 13.**

17. Cutting of polycarbonate. Cut one sheet of polycarbonate (2100x6000mm) according to the dimensions given in the diagram; the remaining sheets are used for roofing.

NOTE: If you received large sheets of 2.10x6.00m and additional ones of 1.05x2.00m, you do not need to cut large sheets according to the given scheme! Large sheets of 2.10x6.00 m are used for the roof and 1.05x2.00 m for the front and rare parts of the greenhouse (doors, and windows). Follow the dimensions given in the table of polycarbonate dimensions (polycarbonate cutting scheme).

18. Fix two pieces of the cut polycarbonate sheets (see polycarbonate cutting diagram) - the side parts (- 5 -, - 6-) and the top one to the window polycarbonate (-9-) at the appropriate mounting points to the frame, using bolts M5-40 and gasket, and fasten other ones to polycarbonate mounting plates with M5-16 bolts and nuts. **SEE Fig. 14**

NOTE: Use plastic "half" gaskets according the arch curvature and at the door-window stud.

NOTE: Do not mistake polycarbonate sides! Attach the side containing a UV protective layer outwards. The UV protective layer is covered with s film with inscriptions and the other side (to be covered inside) is covered with a transparent film.

WEAR GLOVES WHEN CUTTING! It is recommended to cut the sheets with an electric circular saw, a manual saw with small teeth, a sharp knife.

If the polycarbonate side parts protrude above the arch frame part, align them by cutting exactly to the frame part.

19. After placing polycarbonate sheets on the front part of the greenhouse, do the same for the rear part of the greenhouse. After cutting polycarbonate sheets (see polycarbonate cutting diagram -7 -, - 8 -, - 3 -, - 9 -) - fasten the side parts, the lower part of the window and the upper part of the door window polycarbonate to the frame with bolts M5-40, nuts and gaskets, and fasten to polycarbonate mounting plates with bolts M5-16 and nuts. **SEE Fig. 15.**

20. Door-window assembly. Connect all the parts provided in the door complete set into a square.

Use the forked unit for fixing the corners, by tightening them with using bolts M5-16 and nuts.

Attach the vertical door part to the horizontal door parts using the T-pieces M5-16 with nuts.

NOTE: Door shall be fixed to the door studs with the door closed, via canal polycarbonate at designated points. SEE Fig. 16 and 17.

After attaching the door frame, place it in the front part of the polycarbonate greenhouse door and the rear window. **SEE Fig. 18 and 19.**

21. Apply aluminium foil sealing tape (No 34) at the front and rear part of the greenhouse on the open canals of the upper canal polycarbonate cut according to the frame. Seal the upper polycarbonate canals of the door-window with a protective panel tape. **SEE Fig. 20.**

22. Put the upper solid polycarbonate sheets from the bottom to the top, starting with one edge, leaving

a ~ 5 cm overlap at the edges. The polycarbonate is fastened with bolts M5-40, nuts M5 and gaskets. Only fit exactly at the specified fixing points. One arch has 8 fixingpoints - 4 on one side and 4 on the other.

Attach the other side at the appropriate fixing points from the top to the bottom with good tension on the sheet. If the polycarbonate solid sheet (2100 x 6000 mm for the roof) is too long, cut to evenly attach to the side of the foundation base. At the front and back of the greenhouse, polycarbonate sheets should protrude evenly with the edge of the foundation base.

The next upper solid sheet of polycarbonate (2100 x 6000 mm for the roof) should be placed ~ 5-7 cm on the already attached sheet and also screwed only in designated points using bolts M5-40, nuts M5 and gaskets. The polycarbonate sheets should protrude evenly with the edge of the foundation base at the front and rear part. **SEE Fig. 21**

NOTE: Where the sheets overlap on each other, we fix every fourth arch with the same bolt with nut and gasket.

23. Install the handles (No.29) in the already prepared door-window points.

We recommend making the mounting hole for the handle mounting on the sheet by using a construction knife by cutting X-shaped holes at the metal holes. Make an opening on the external part of the coating.

SEE Fig. 22

NOTE: Fix at the edges using “half” gaskets.

24. Screw-in the eyebolt (No. 36) into a specially designated point.

One eyebolt is fixed at the bottom corner of the door, the other on the edge of the greenhouse roof, almost in parallel (slightly above) with the loop in the door. Attach the door opening chain (No37). **SEE Fig. 23.**

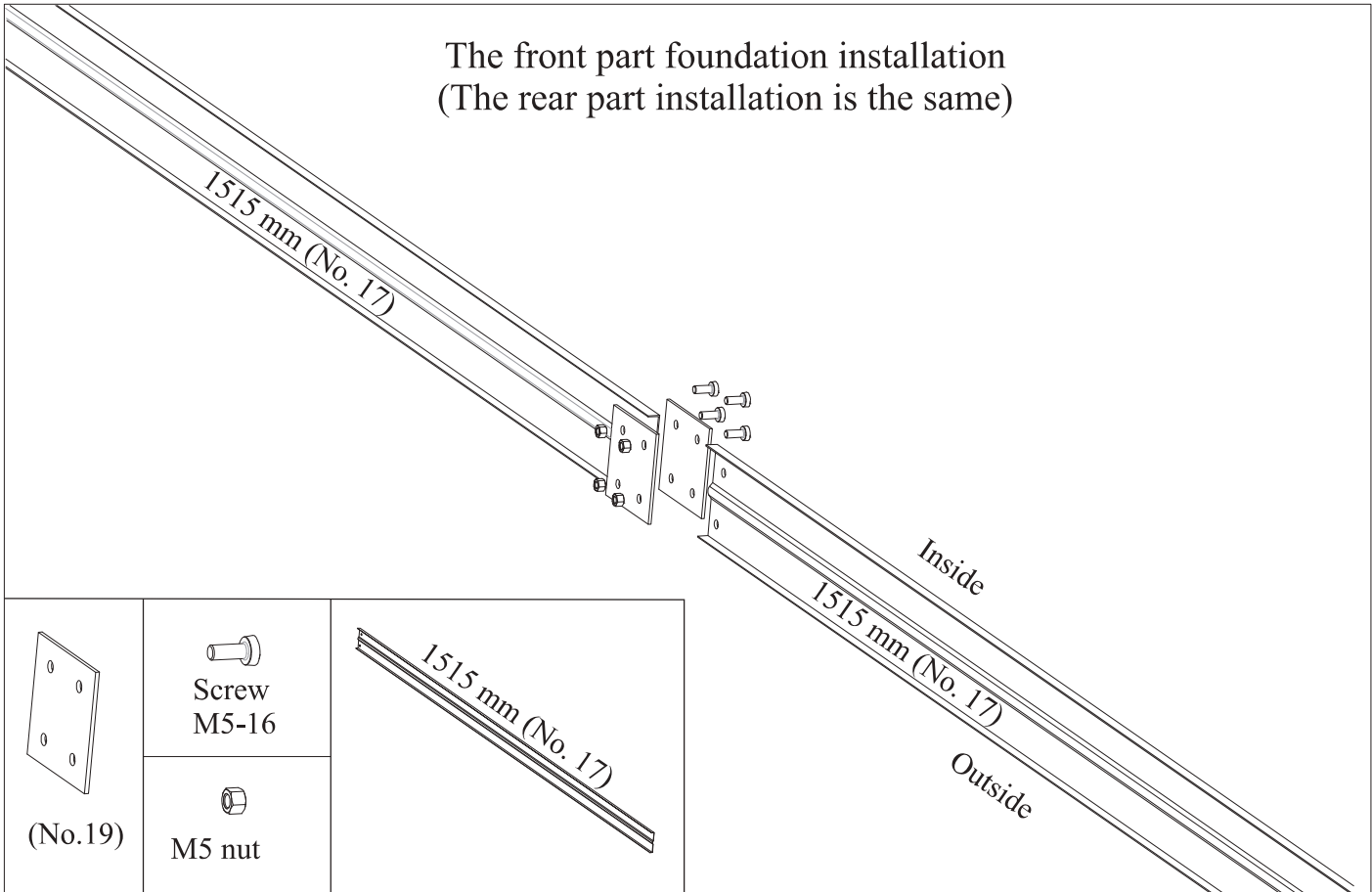

1 Fig.

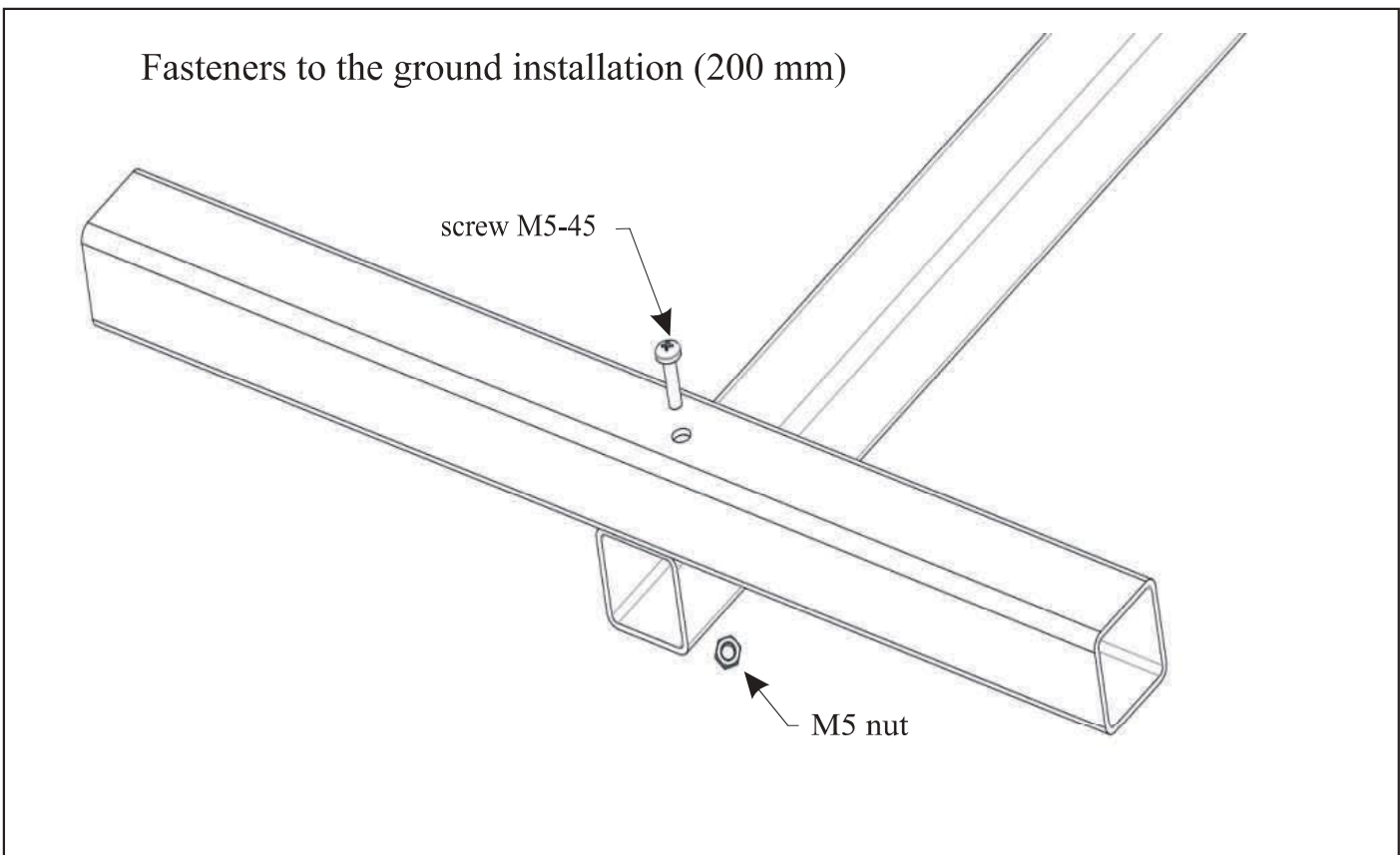

2 Fig.

Connection of the foundation side part
(in the left and in the right side installation the same)

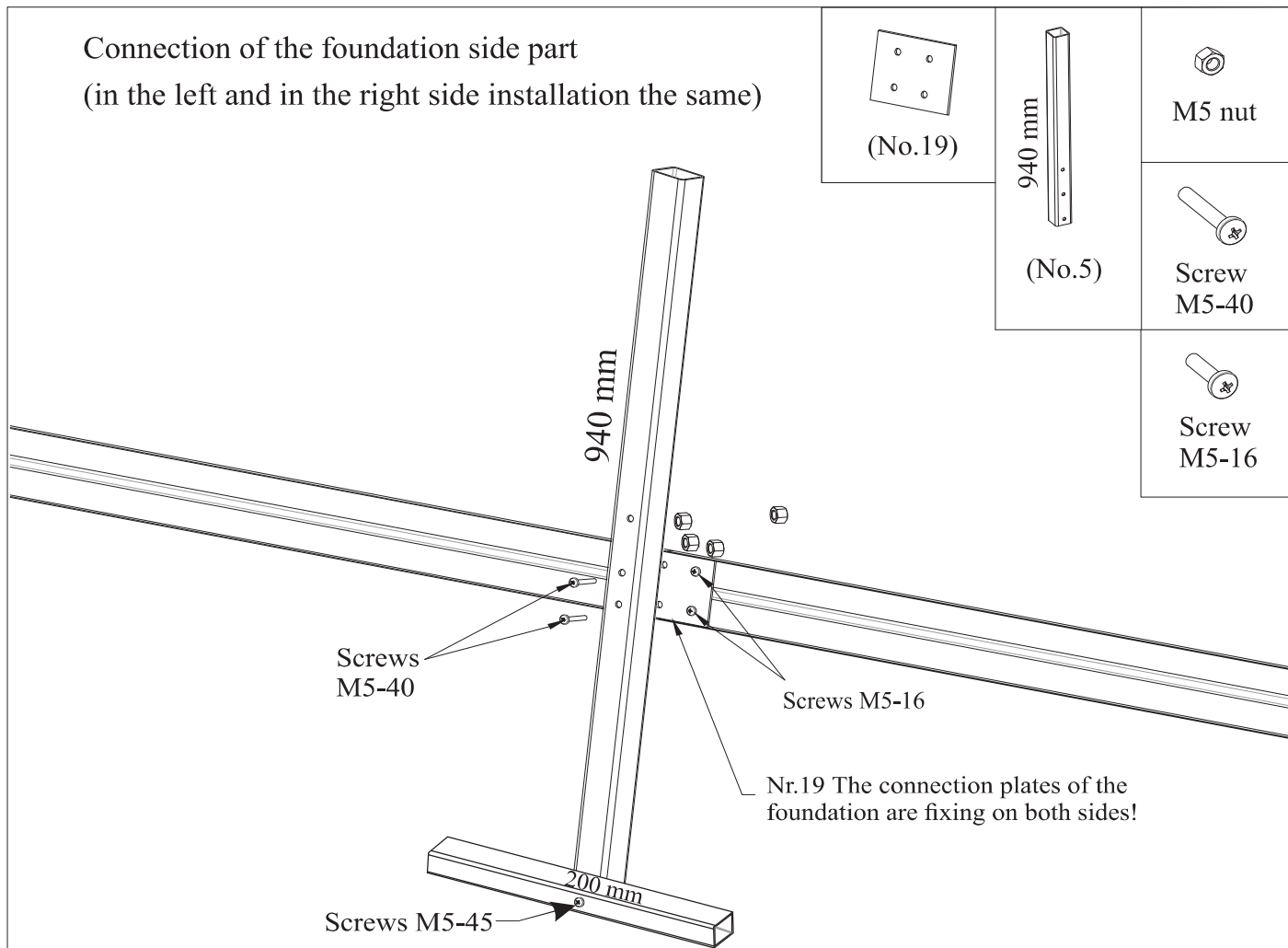

3 Fig.

Installation of lateral lower arch part

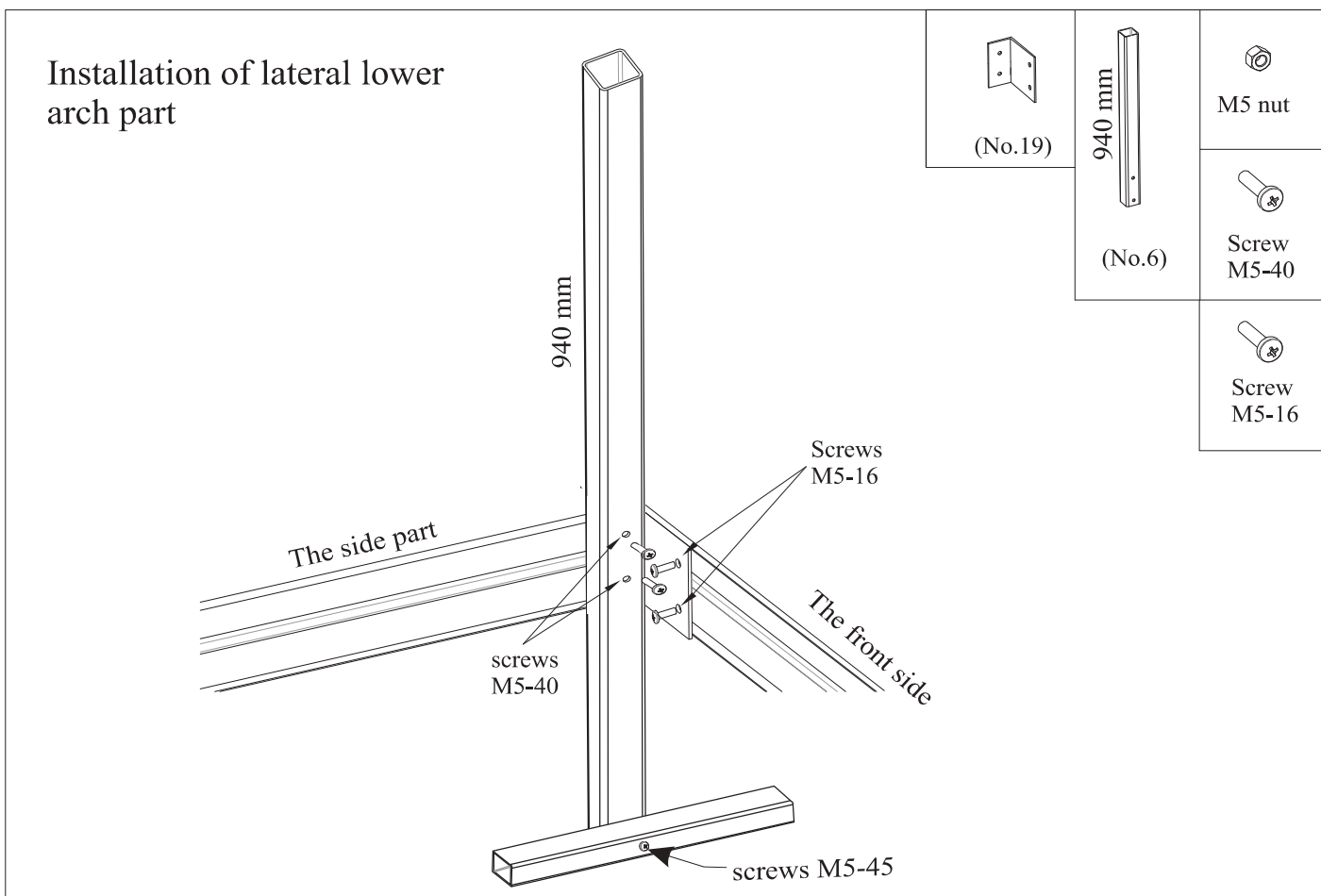

4 Fig.

$$a = b$$

NOTE:
The diagonal lengths must be equal!

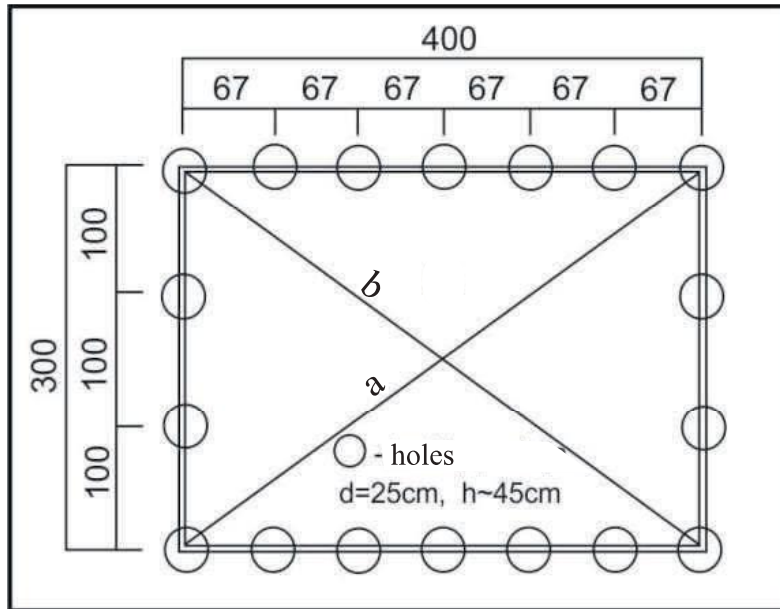

5 Fig.

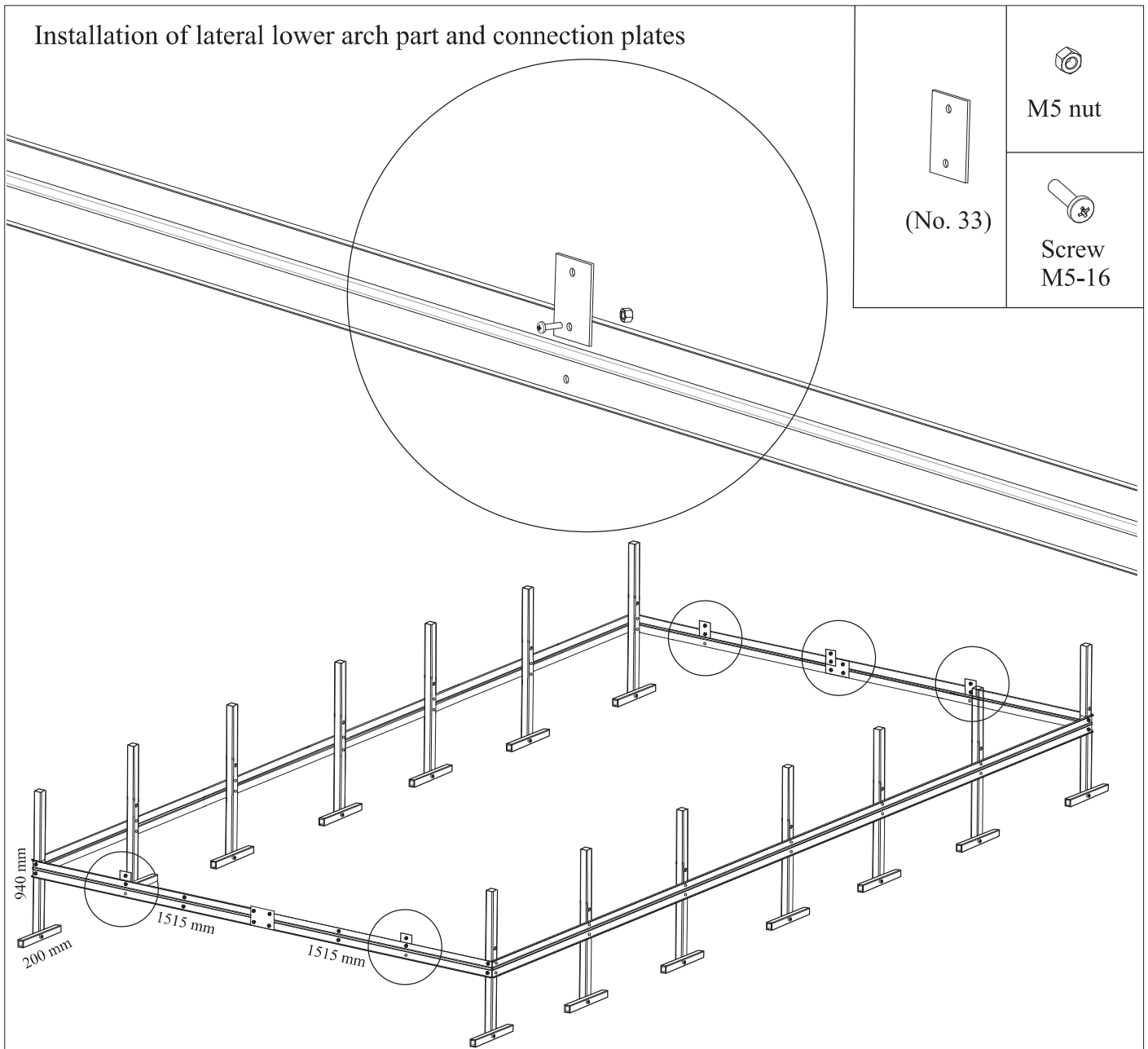

6 Fig.

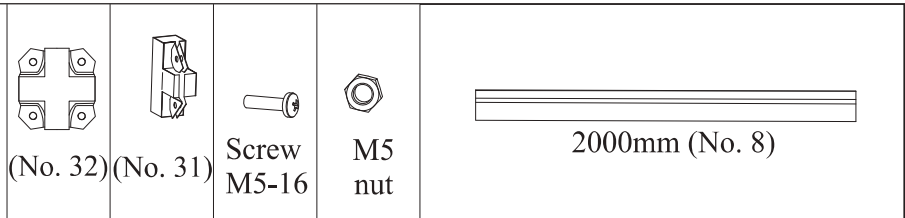

Four-branch connection and T-piece connection plates installation for 2m length (6m²) greenhouse

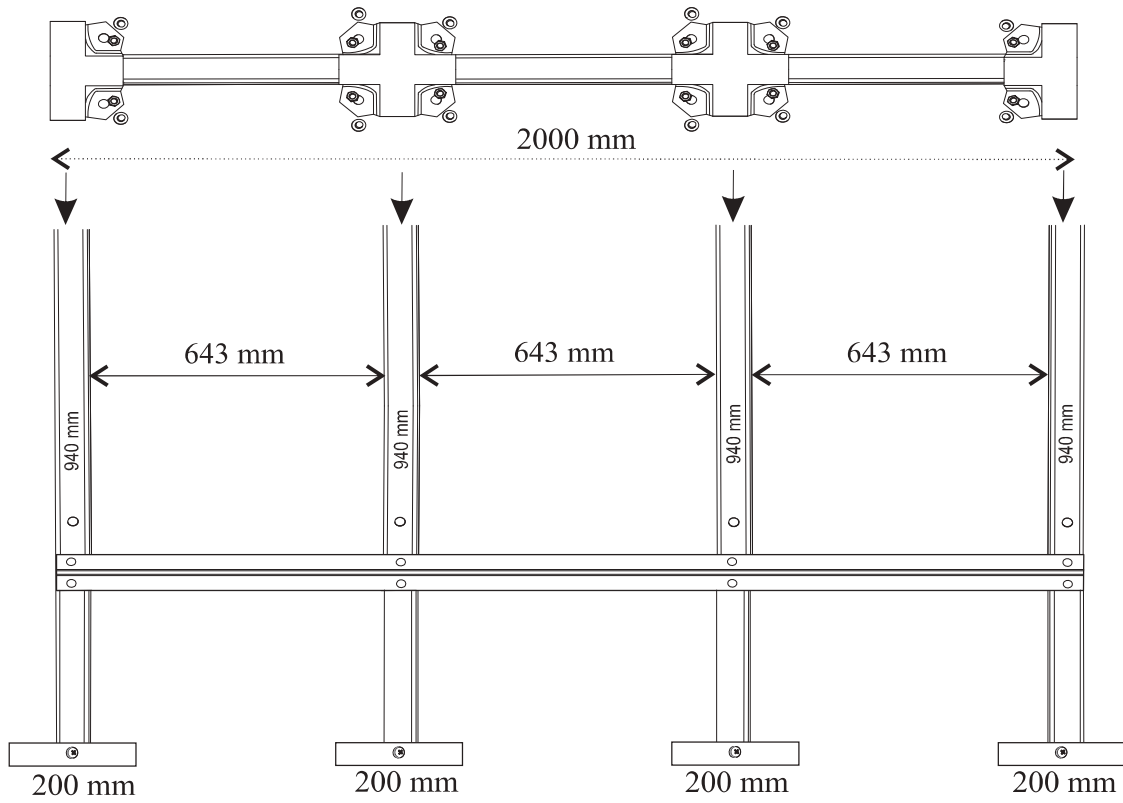

Four-branch connection and T-piece connection plates installation for 4m length (12m²) greenhouse

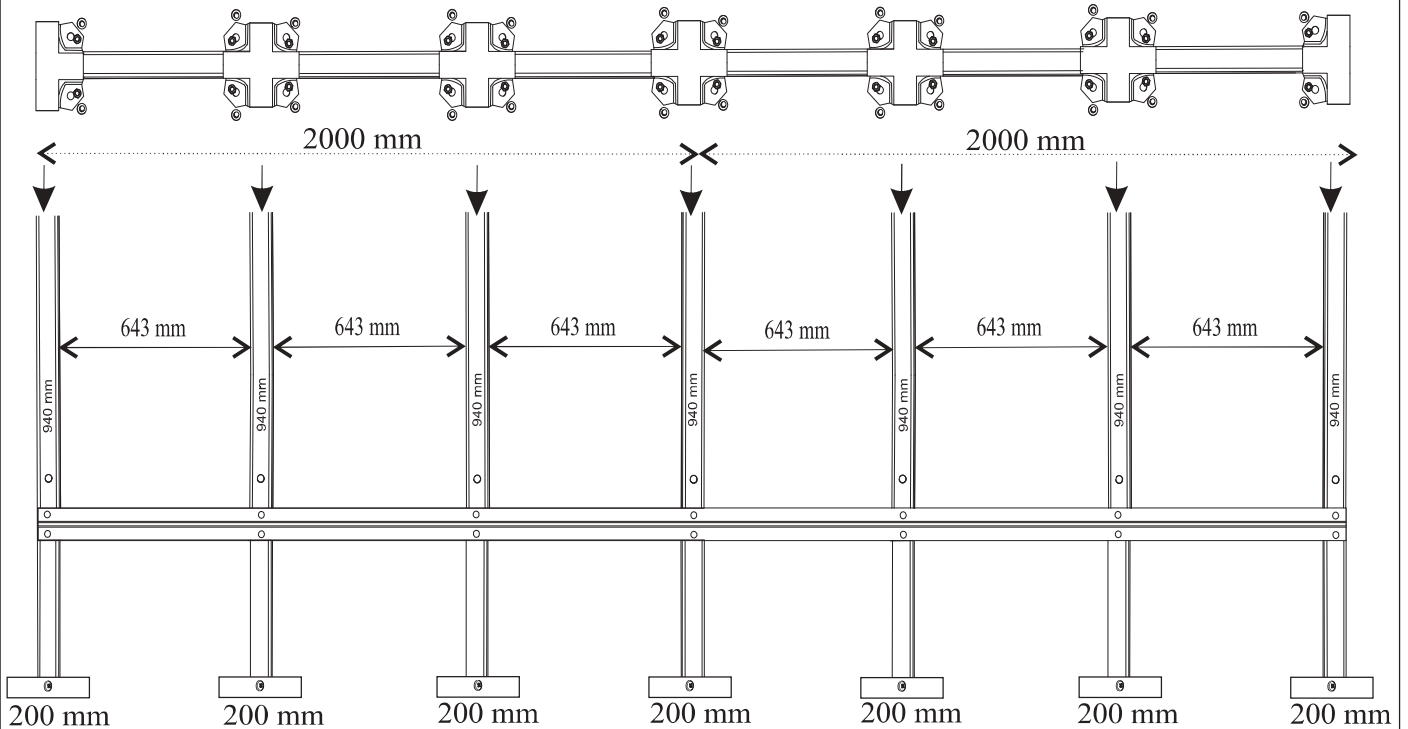

7 Fig.

Installation of the side arches

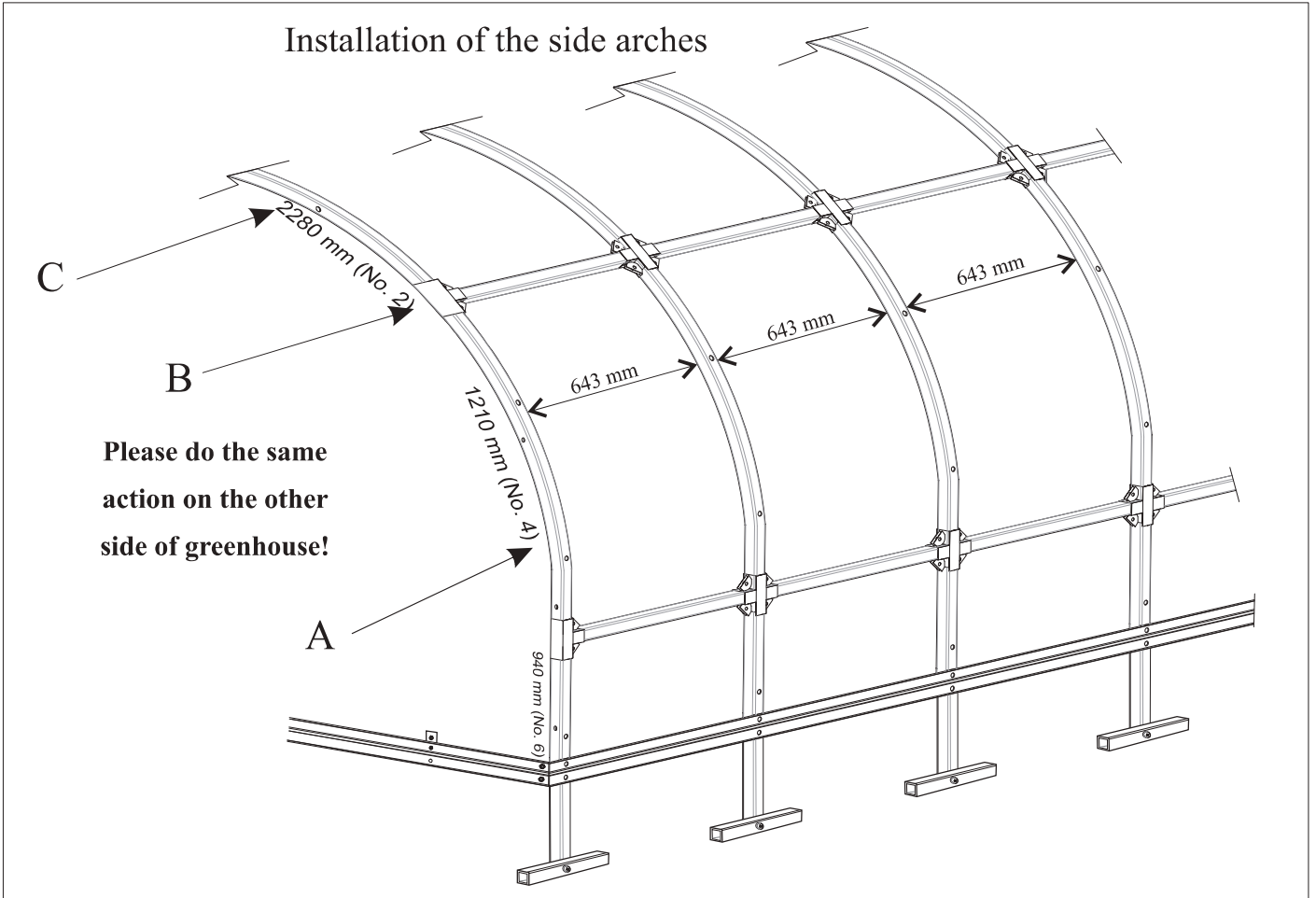

8 Fig.

Installation of the Arch fastening crossbars

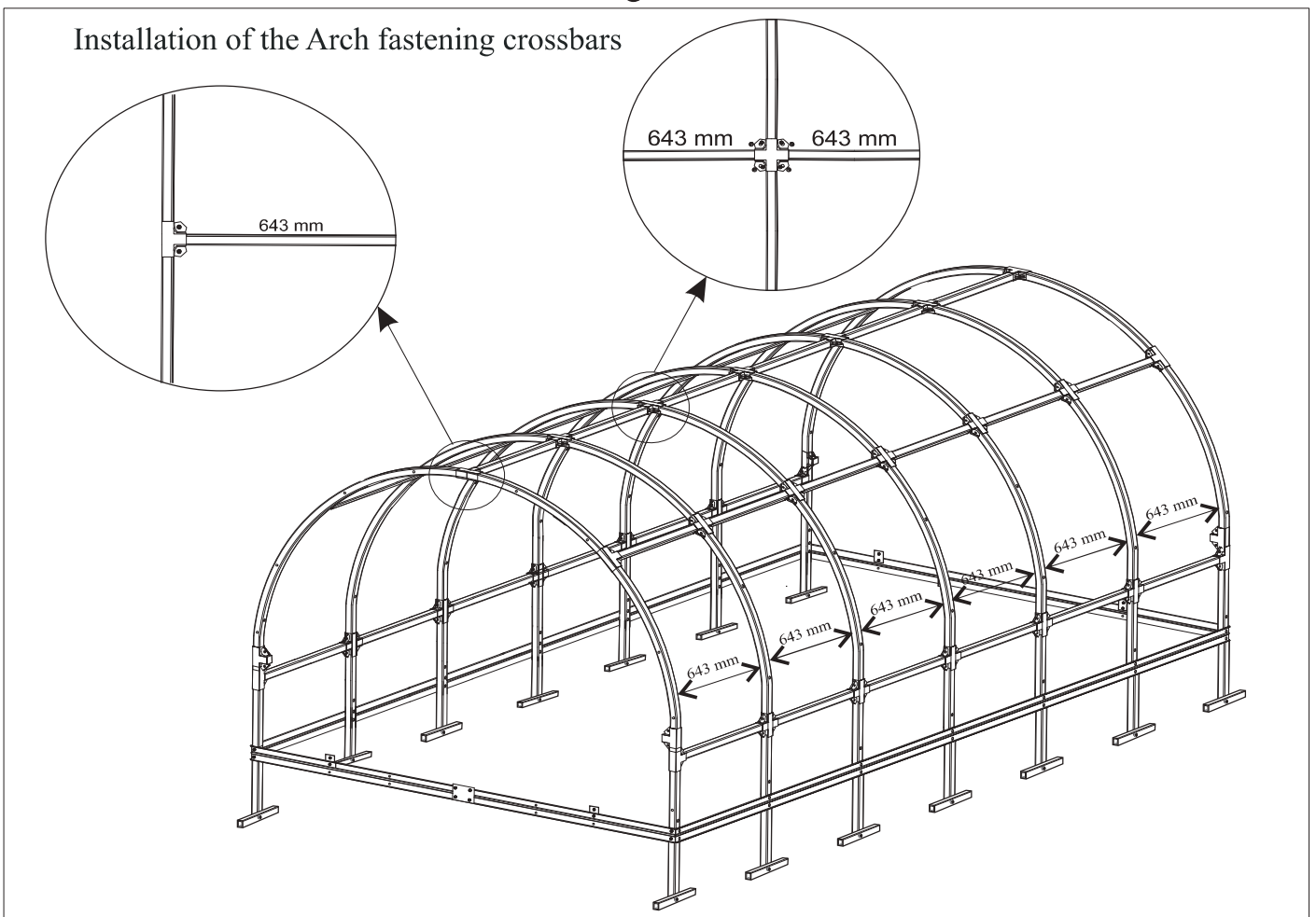

9 Fig.

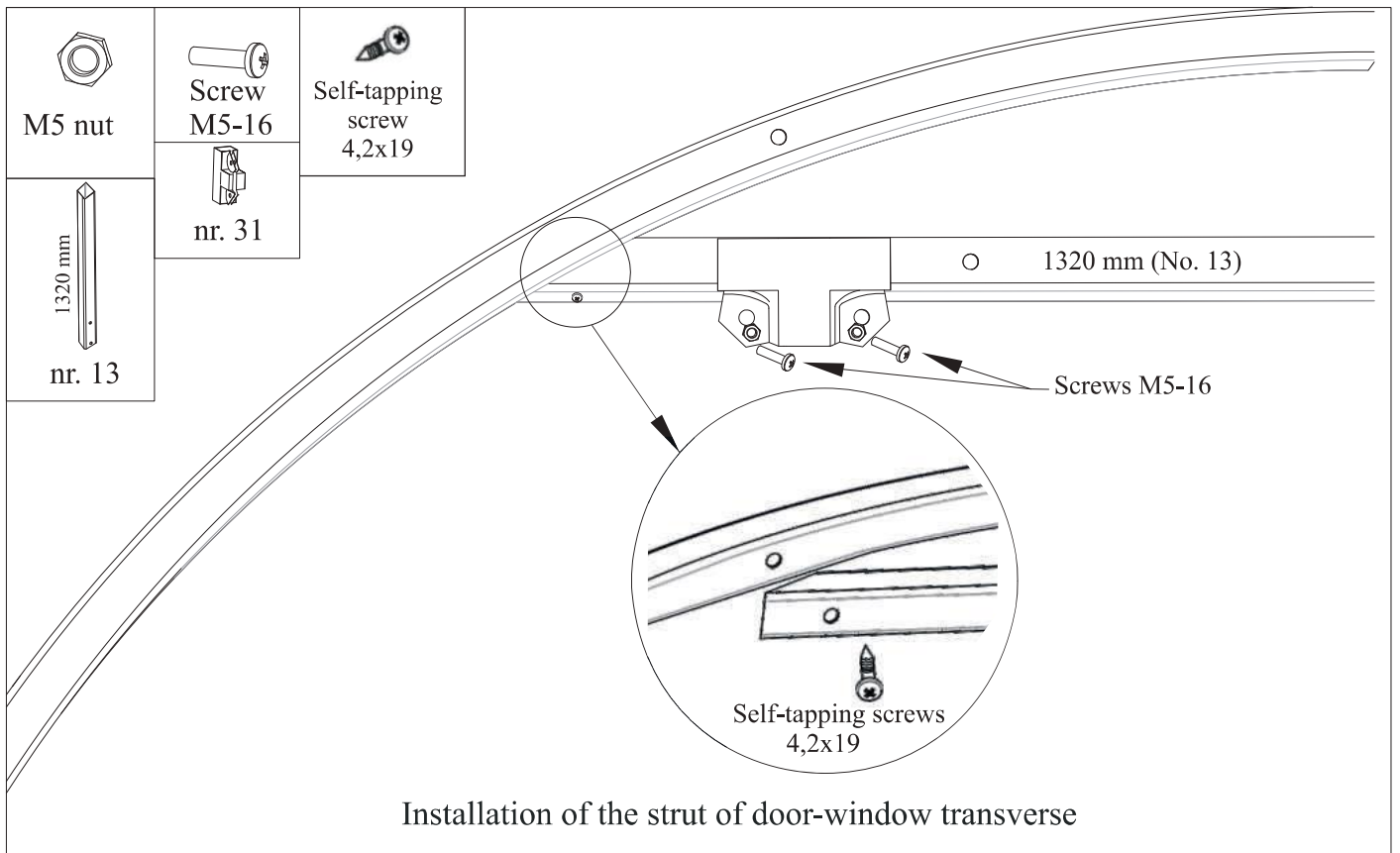

10 Fig.

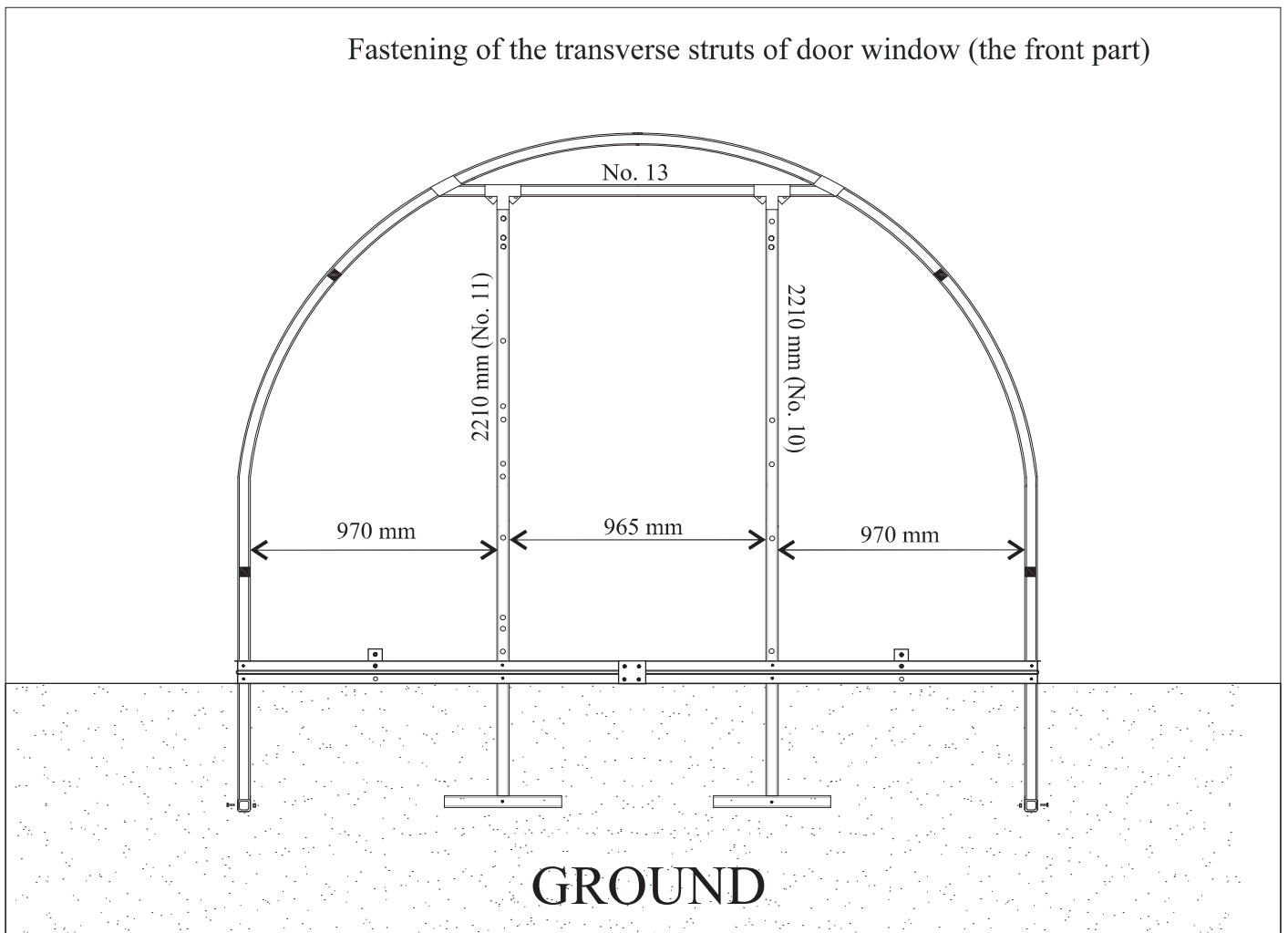

11 Fig.

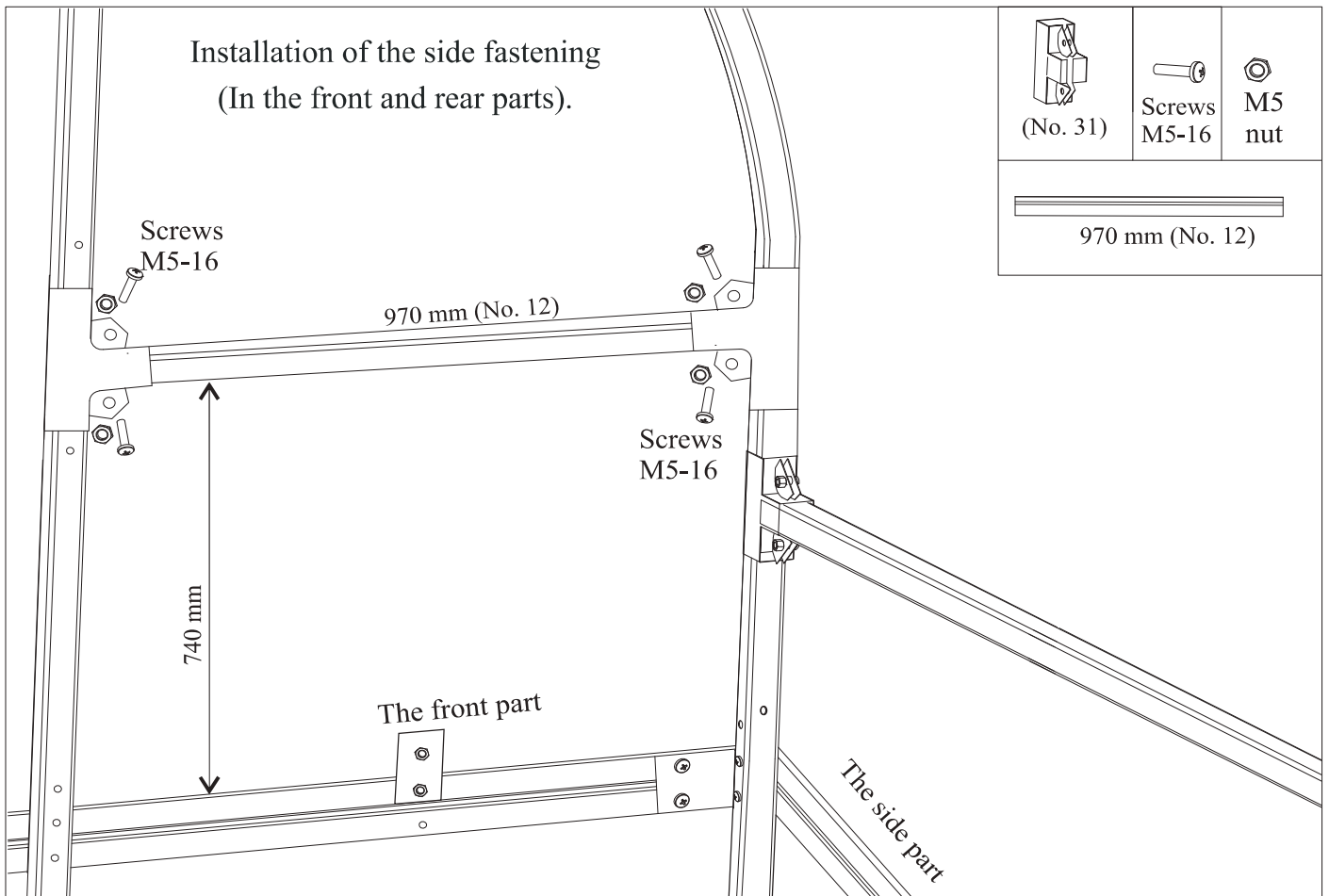

12 Fig.

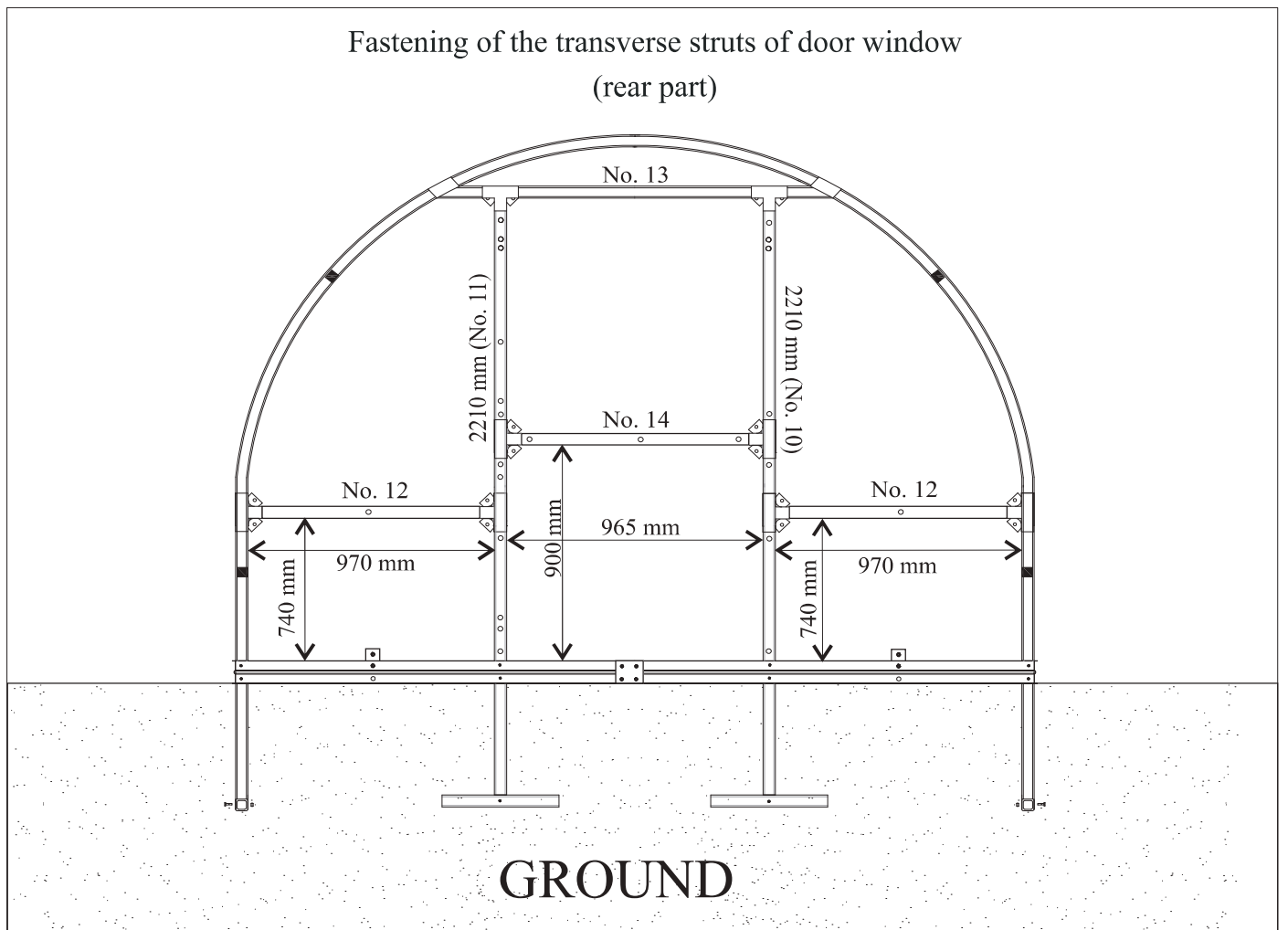

13 Fig.

Installation of the polycarbonate to the side parts and door cover (front)

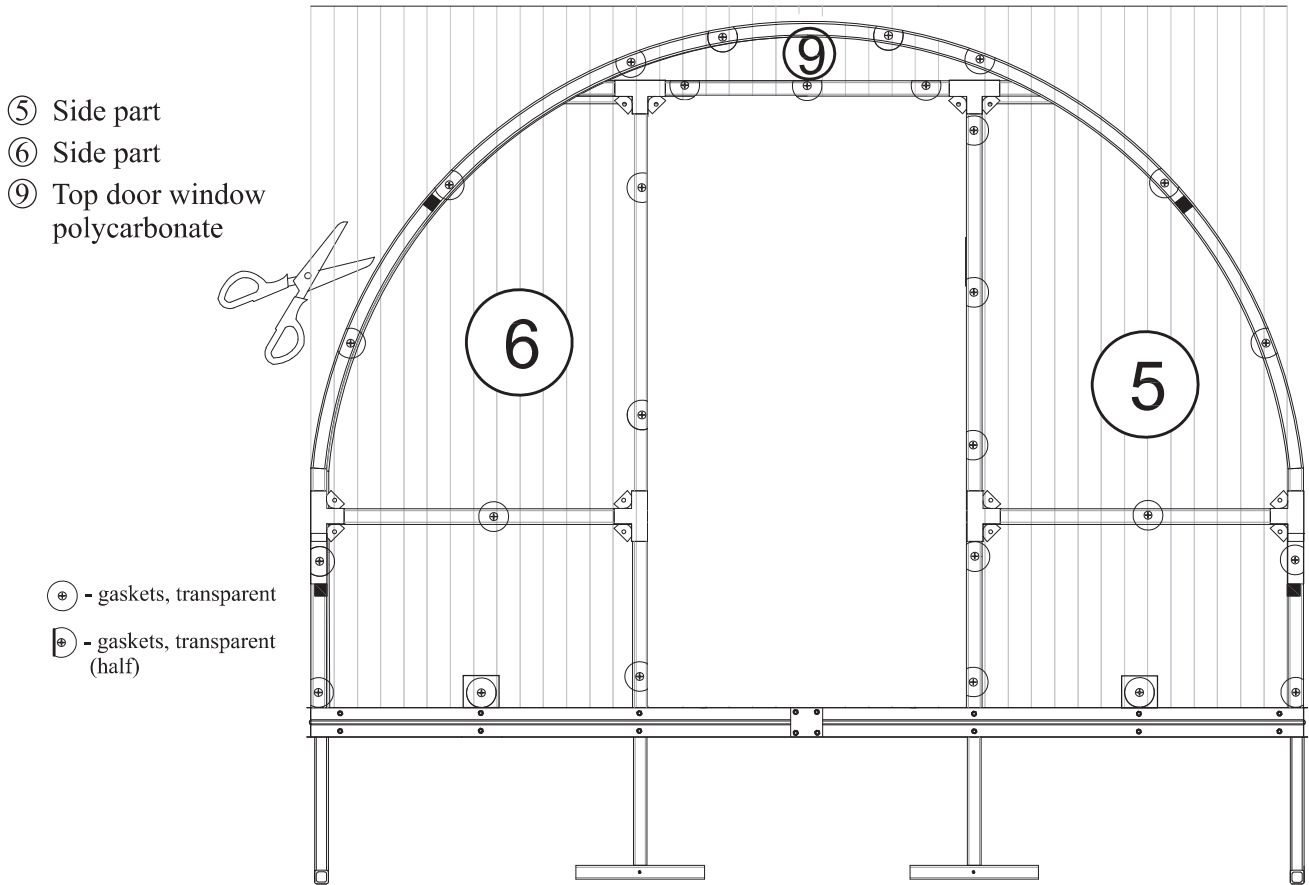

14 Fig.

Installation of the polycarbonate to the side parts and the bottom of the window (rear)

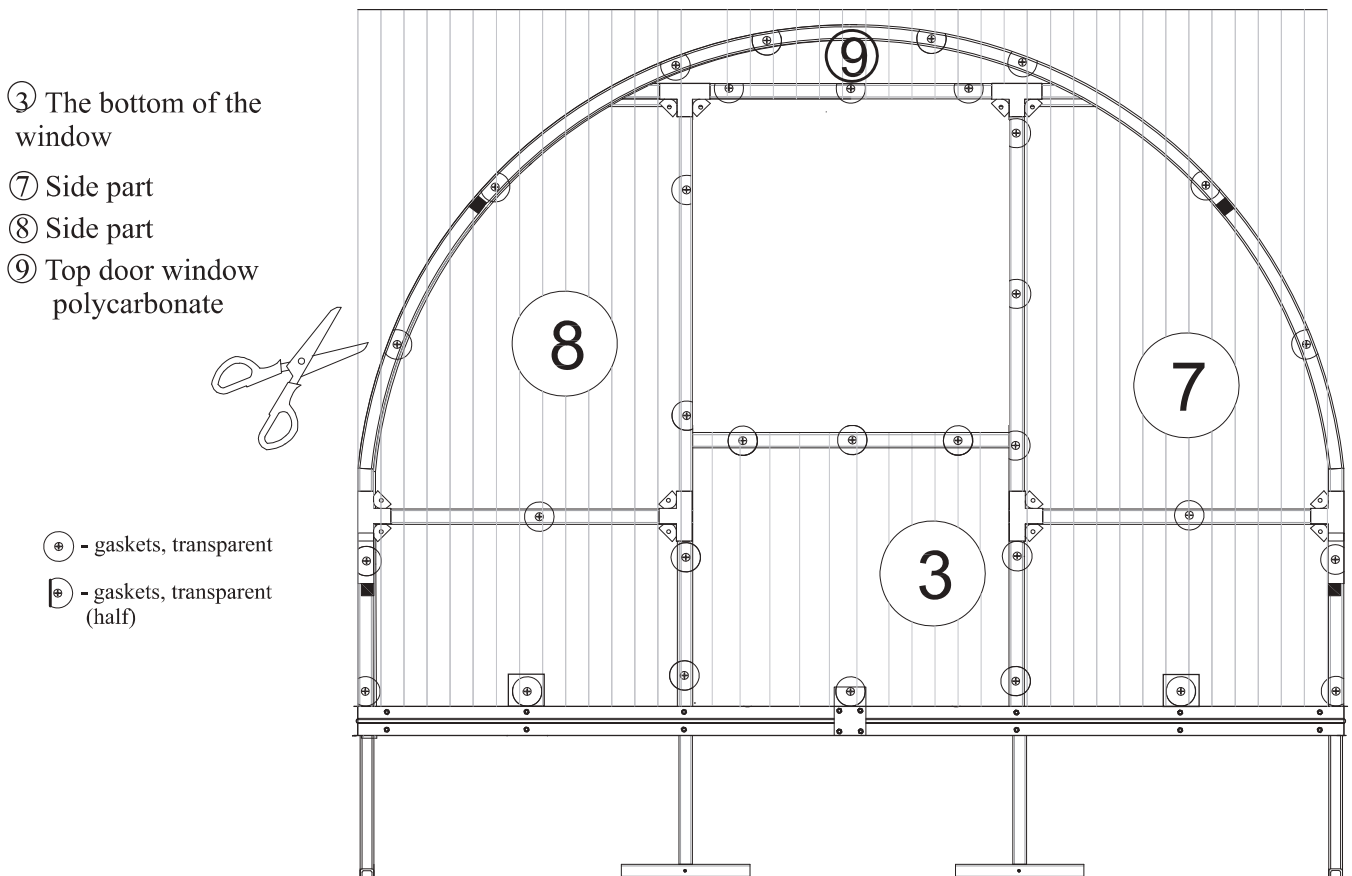

15 Fig.

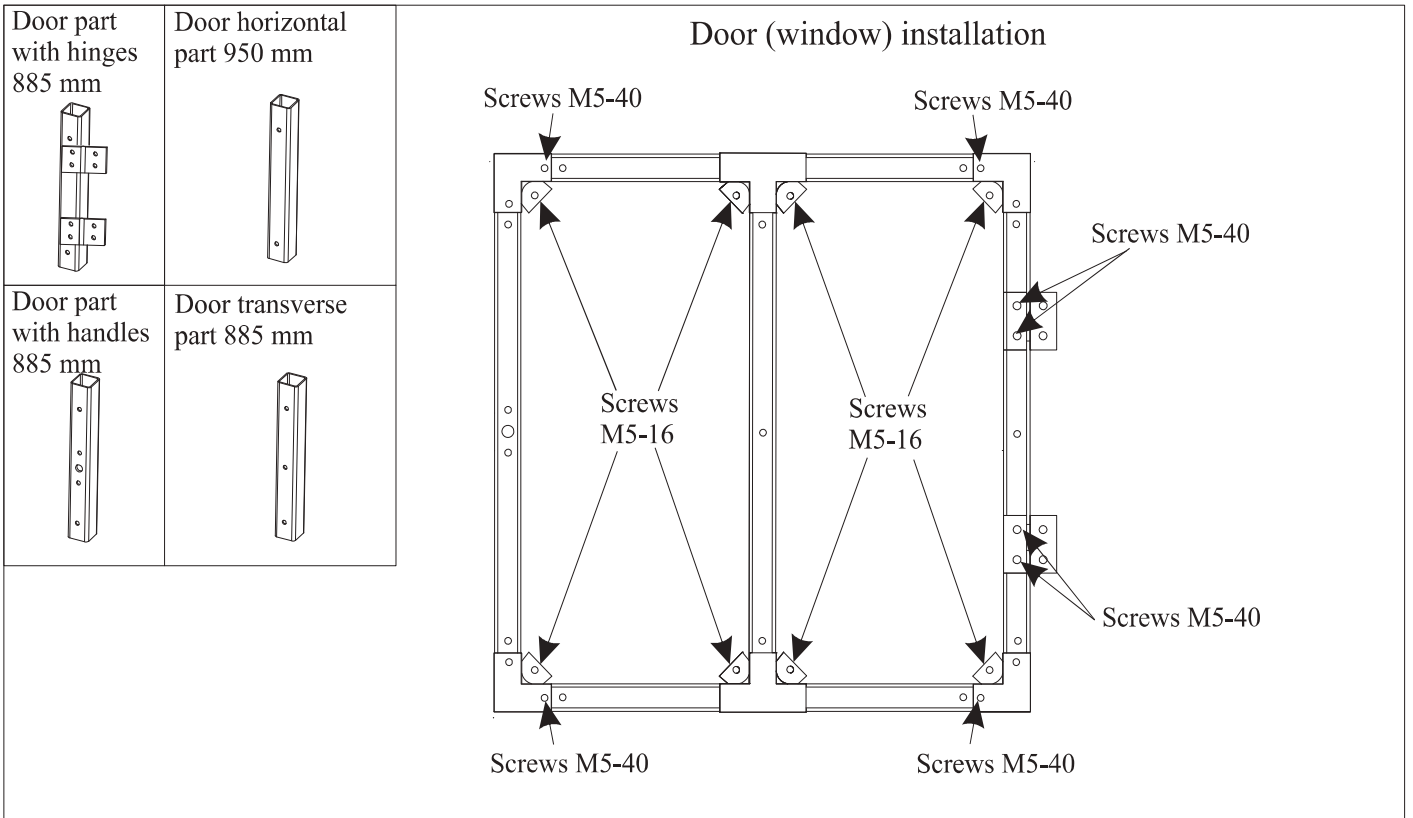

16 Fig.

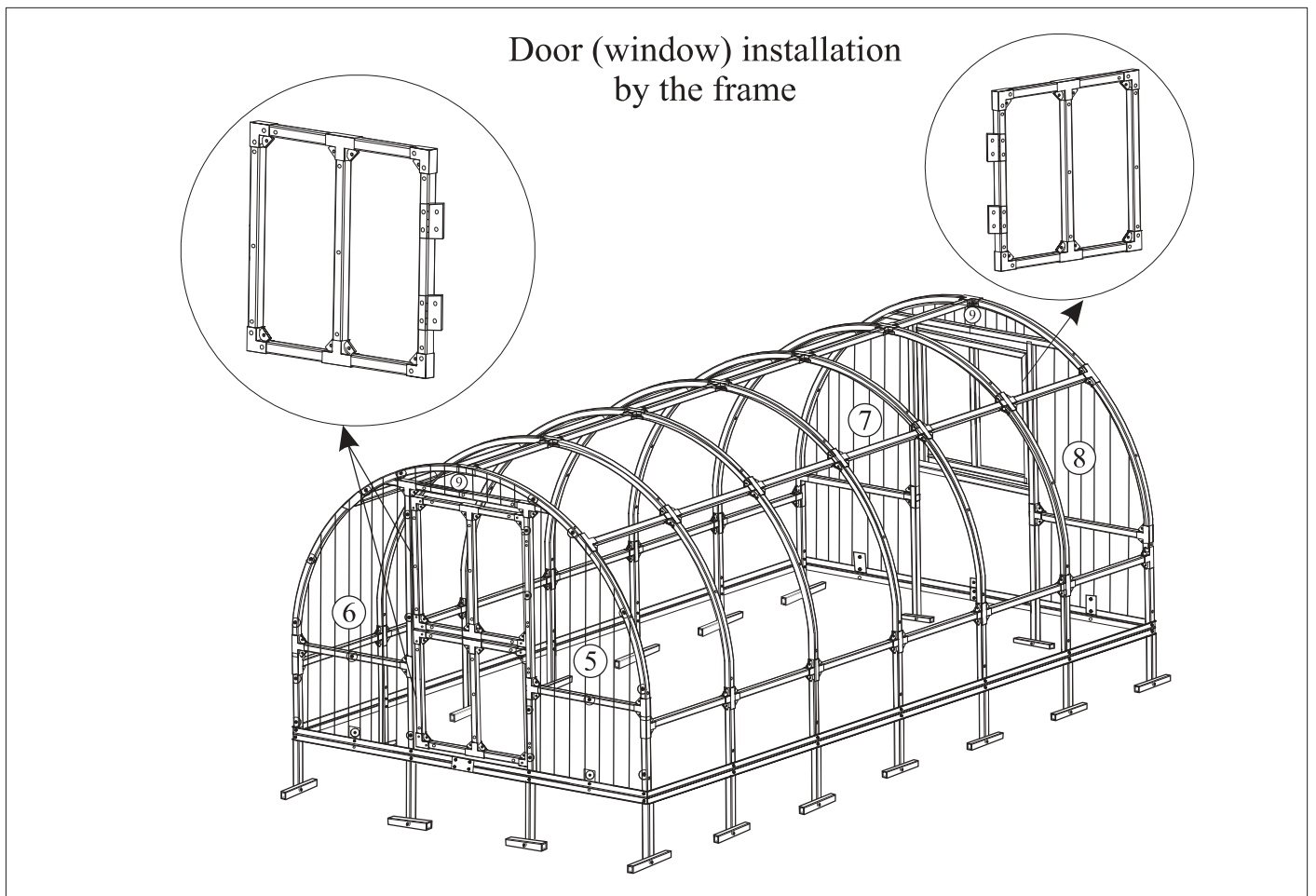

17 Fig.

Installation of the polycarbonate to the side parts and doors (front)

- ① The upper part of door
- ② The bottom part of the door
- ⑤ Side part
- ⑥ Side part
- ⑨ Top door - window polycarbonate

- ⊕ - full gasket
- ⊖ - gasket (half)

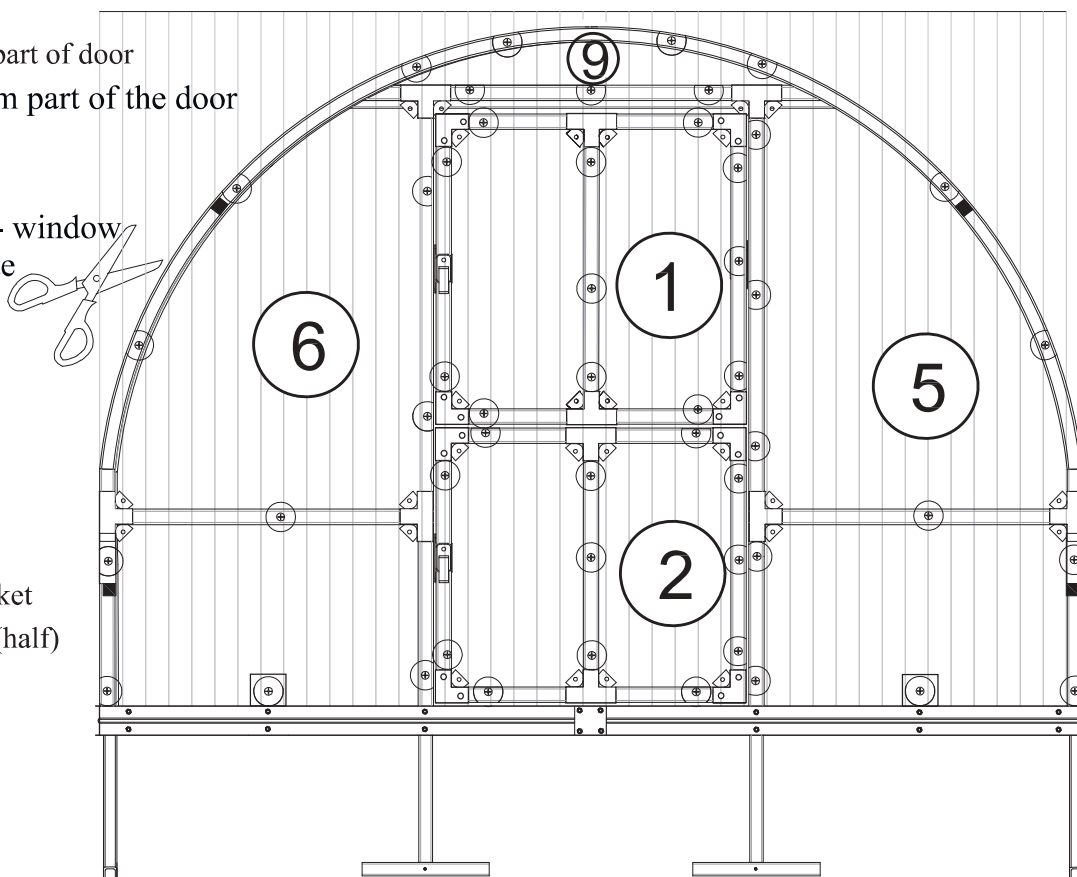

18 Fig.

The rear part installation

- ③ The bottom of the window
- ④ Window
- ⑦ Side part
- ⑧ Side part
- ⑨ Top door - window polycarbonate

- ⊕ - full gasket
- ⊖ - gasket (half)

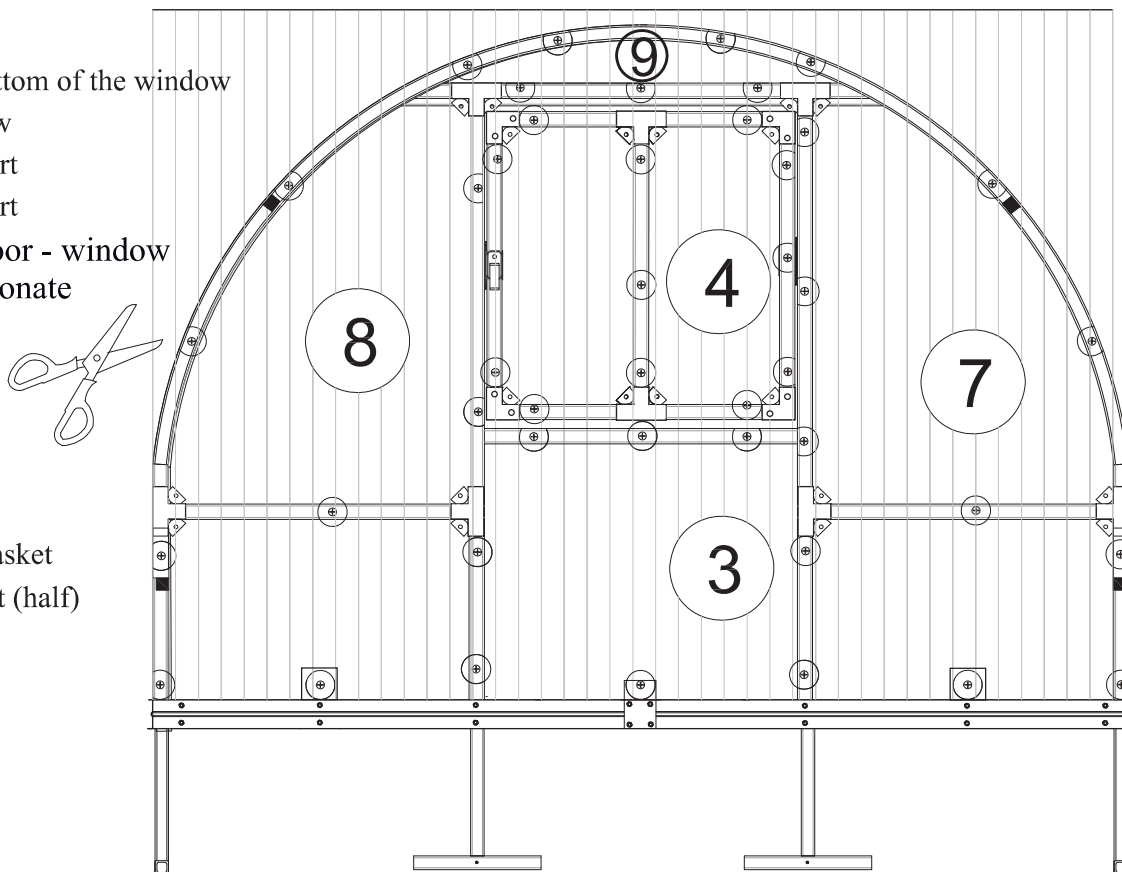

19 Fig.

Protective sealing tape for slabs

Protective sealing tape
for slabs



Protective sealing tape please to glue on the upper polycarbonate channels. This step please do before covering the roof cover.

The same action please do with upper door-window polycarbonate channels.

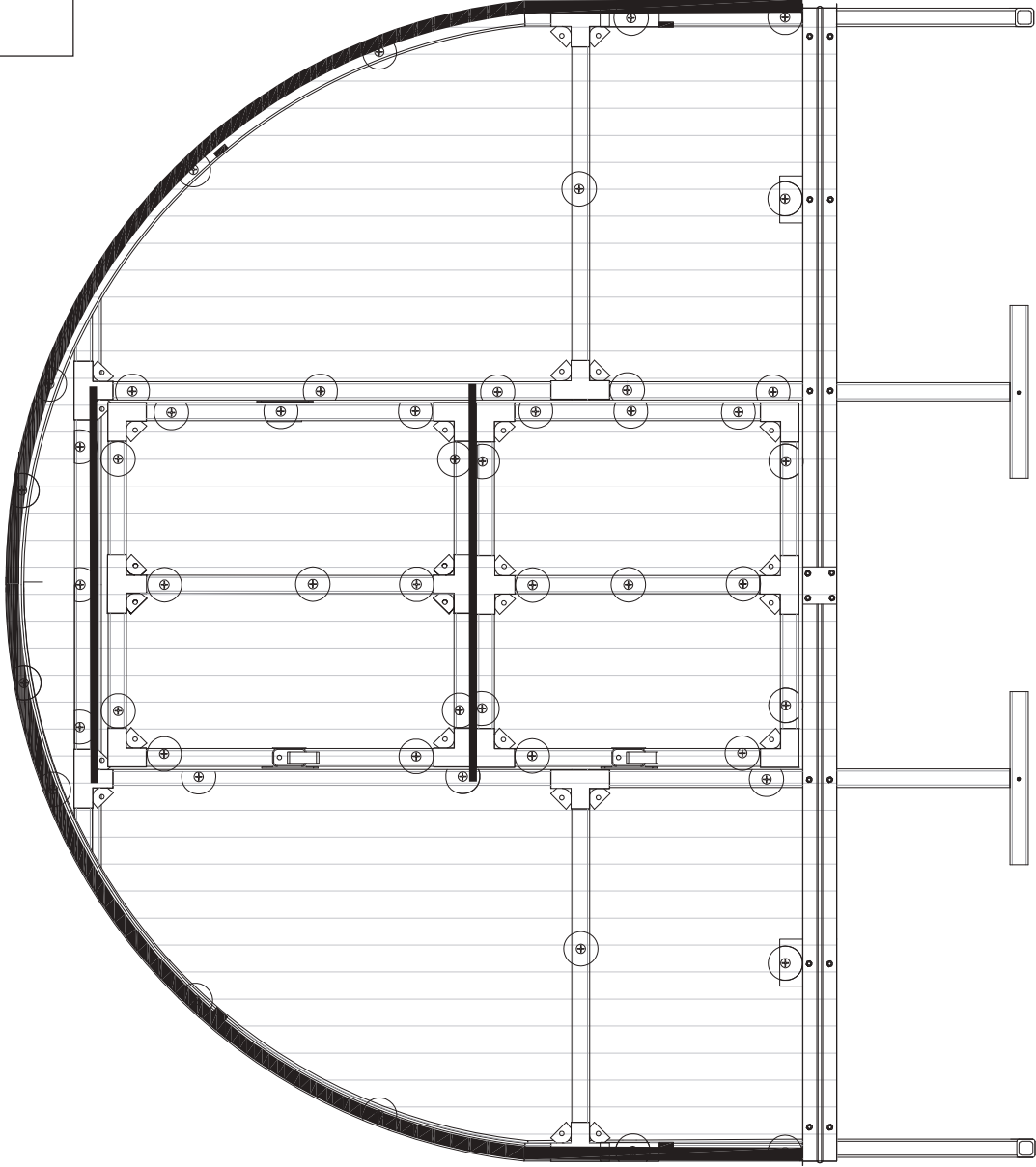

20 Fig.

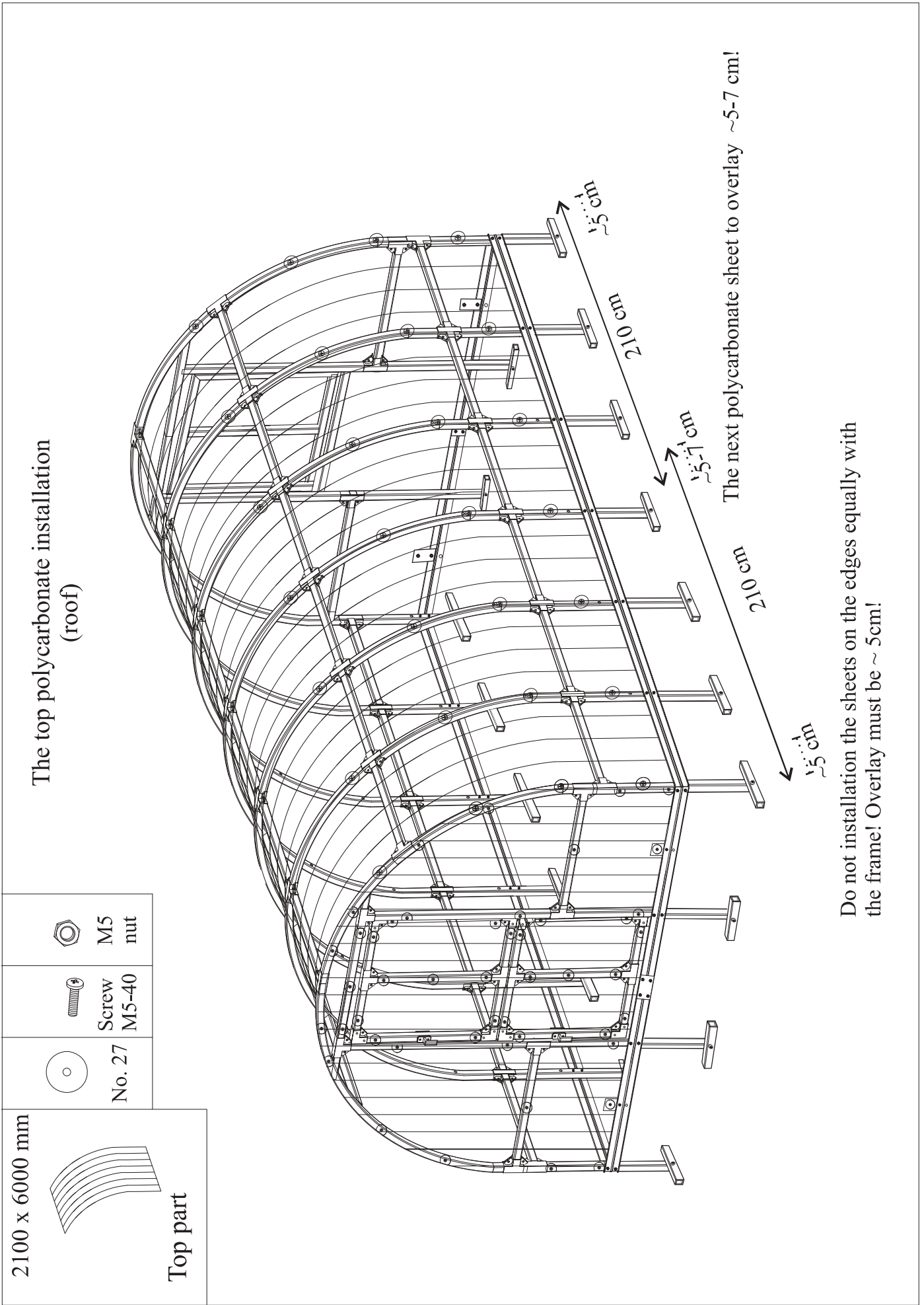

21 Fig.

Door handle installation

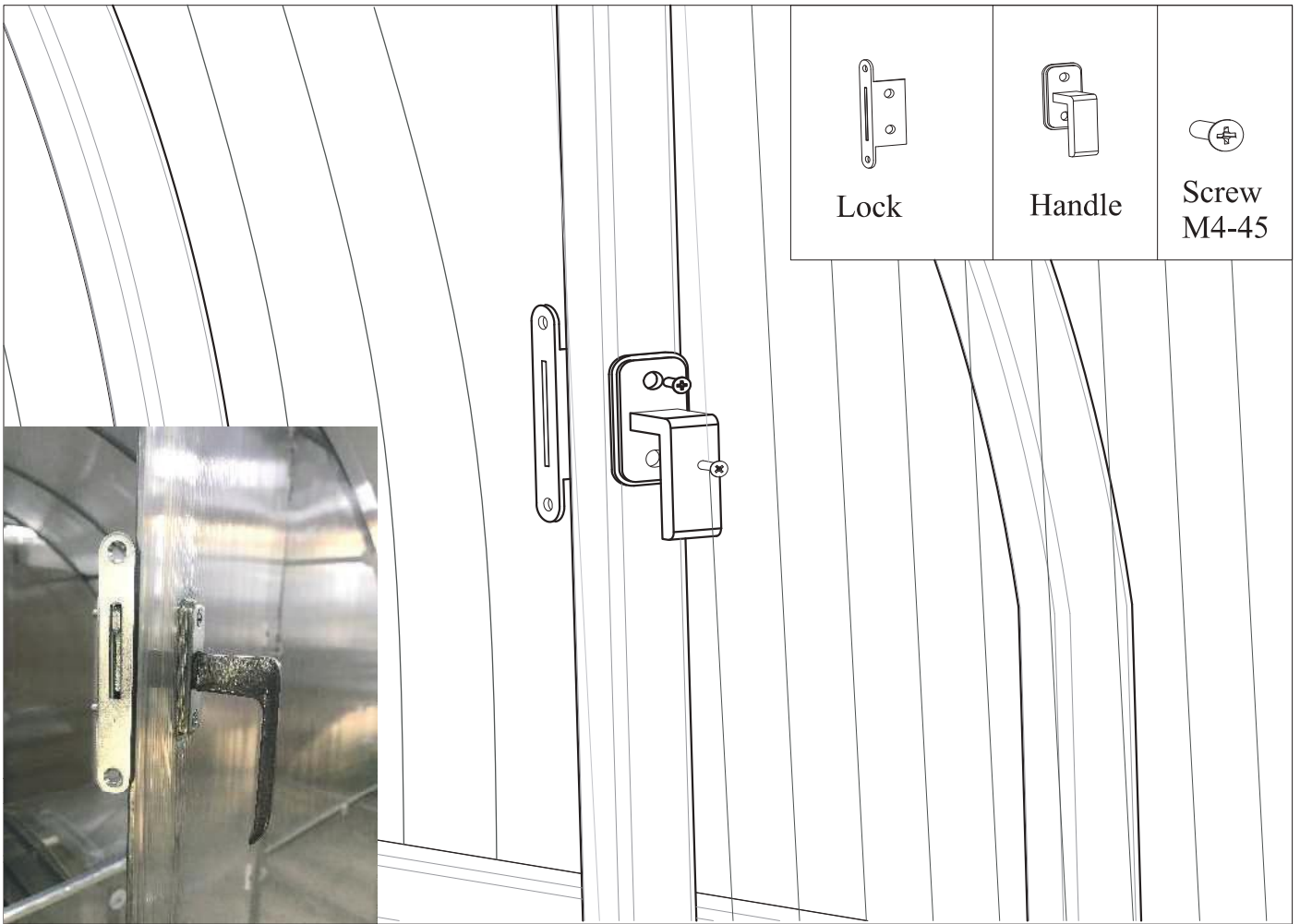

NOTE: Do not over tighten the screws. If the handle turns hard, please to loosen slightly the screws (M4-45).

22 Fig.

Door holder installation (upper part)



23 Fig.

Contact information

Austria



Belgium



Croatia



Denmark



Estonia



Finland



France



Germany



Ireland



Italy



Latvia



Lithuania



Nederland



Norway



Poland



Portugal



Spain



Sweden



Switzerland



UK

