

DANCOVER[®]



Manual
for
Greenhouse TITAN Classic 480

Dear customers!

After you had decided to purchase a greenhouse you have received a product produced the utmost care. Its especially strong frame is made of special galvanized metal profiles of 1 mm thickness. The greenhouse is easy to assembly due to its simple design. Many different accessories will allow you to implement your ideas. *We reserve the right to make changes and improvements related to technological progress. Due to that mismatches between descriptions and illustrations may occur.* We wish you a lot of joy and success upon purchase of our greenhouse.

ATTENTION!

When assembling the frame of the greenhouse and working with a coating made of cellular polycarbonate always wear safety gloves or protective working measures.

To assembly the greenhouse you will need the following tools:

- 8mm diameter hexagon wrench or an open-end wrench.
- A Phillips screwdriver or a battery-powered screwdriver.
- A shovel (to dig holes)
- A level (to measure flatness of a pad)
- Ropes (to measure a diagonal)
- Knife (to cut polycarbonate sheets)

Follow local building regulations, if necessary.

If a strong wind or a storm occurs, close windows or doors.

Before starting to assembly the greenhouse you must read all instructions at least once and familiarize yourselves with separate sections and profiles. It is your important auxiliary means.

Check supply content according to specifications of parts. IF YOU FIND NONCONFORMITIES WITH THE SPECIFICATION – IMMEDIATELY CONTACT THE SELLER AND NOTIFY HIM ABOUT SHORTAGE OF PARTS.

Then sort out profiles and put them separately.

When assembling the greenhouse it is recommended to tighten bolts manually at first – not tight in order to be able to easily move profiles, if necessary. Level the assembled frame of the greenhouse by using the level, and then tighten the bolts tightly.

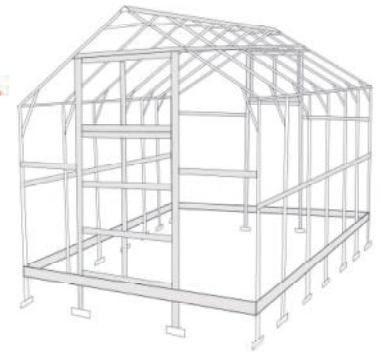

Installation instruction PARTS LIST

Greenhouse base pack

* THE NUMBER OF BOXES DEPENDS ON THE PURCHASED M² SIZE GREENHOUSE!







* Greenhouse area		4,98m ² 2,35x2,12m	7,45m ² 2,35x3,17m	9,68m ² 2,35x4,12m	12,15m ² 2,35x5,17m	14,38m ² 2,35x6,12m	16,85m ² 2,35x7,17m
Box 1/2	BASE Profiles packaging	1	1	1	1	1	1
Box 2/2	BASE Packaging of archs	1	1	1	1	1	1
Box 1/2	EXTENSION Profiles packaging	—	—	1	1	2	2
Box 2/2	EXTENSION Packaging of archs	—	—	1	1	2	2
TOTAL PACKAGING		2	2	4	4	6	6

Table NO.1

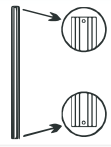
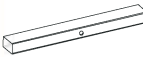
NR.	Name	Length (mm)	Photo	Box 1/2 BASE Profiles packaging		Box 1/2 EXTENSION Profiles packaging
				Greenhouse area		2m EXTENSION
				4,98m ² 2,35x2,12m	7,45m ² 2,35x3,17m	
				2350x110x110mm 61,75kg	3150x110x110mm 90kg	2100x100x70mm
Number in package (pcs.)						
NR. 1	Side - lower bar	1870		10	14	8

TITAN Classic 480

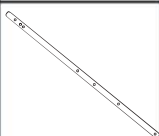
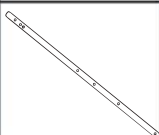
Table NO.1

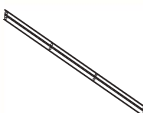
NR.	Name	Length (mm)	Photo	Box 1/2		Box 1/2
				BASE Profiles packaging		EXTENSION Profiles packaging
				Greenhouse area		2m EXTENSION
				4,98m ² 2,35x2,12m	7,45m ² 2,35x3,17m	
2350x110x110mm 61,75kg	3150x110x110mm 90kg	2100x100x70mm 35kg				
Number in package (pcs.)						
NR. 2	Upper bar	1345		10	14	8
NR. 3	Fixing profile for doors and a ridge	425		15	21	12
NR. 4	Stiprinajums zeme	200		14	18	8
NR. 5	Bar fixing- crossbars for 3.17m greenhouse	2080		—	4	—
NR. 6	Bar fixing- crossbars for 2,12m greenhouse	2065		4	—	—
NR. 7	Bar fixing- crossbars for extension	2070		—	—	4
NR. 8	Door and back bar	2235		4	4	—
NR. 9	Door and back bar holder (at the top)	1025		2	2	—
NR. 10	Side fixtures for the front-rear part	630		4	4	—
NR. 11	Fixtures for the rear part (in the middle)	920		1	1	—

TITAN Classic 480

Table NO.1

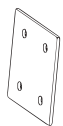
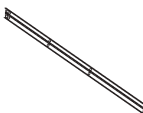
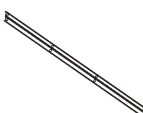
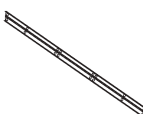
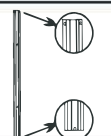
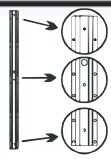
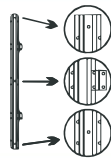
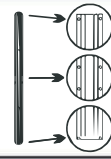
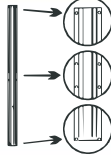
NR.	Name	Length (mm)	Photo	Box 1/2		Box 1/2
				BASE Profiles packaging		EXTENSION Profiles packaging
				Greenhouse area		2m EXTENSION
				4,98m ² 2,35x2,12m	7,45m ² 2,35x3,17m	
2350x110x110mm 61,75kg	3150x110x110mm 90kg	2100x100x70mm 35kg				
Number in package (pcs.)						
NR. 12	Connector of the upper bar (a plate with 4 holes)			15	21	12
NR. 13	Sides of the foundation for 3.17m length greenhouse	3120		—	2	—
NR. 14	Sides of the foundation for 2.12m length greenhouse	2065		2	—	—
NR. 15	Sides of the foundation for greenhouse extension	2010		—	—	2
NR. 16	Front and back parts of the foundation	2325		2	2	—
DOOR (upper part) – small						
DOOR NR.1	Part of the door whit loop	580		2	2	—
DOOR NR.2	Part of the door wiht handle	580		2	2	—
DOOR NR.3	Cross sections of a door	820		4	4	—
DOOR NR.4	Vertical part of a door	480		2	2	—

TITAN Classic 480

Table NO.1









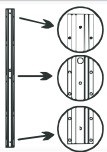
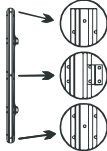
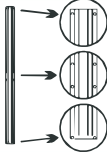
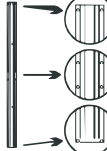

NR.	Name	Length (mm)	Photo	Box 1/2		Box 1/2
				BASE Profiles packaging		EXTENSION Profiles packaging
				Greenhouse area		2m EXTENSION
				4,98m ² 2,35x2,12m	7,45m ² 2,35x3,17m	
2350x110x110mm 61,75kg	3150x110x110mm 90 kg	2100x100x70mm 35kg				
Number in package (pcs.)						
DOOR (bottom part) – large						
DOOR NR.1	Part of the door whit loop	1220		1	1	—
DOOR NR.2	Part of the door wiht handle	1220		1	1	—
DOOR NR.3	Cross sections of a door	820		4	4	—
DOOR NR.4	Vertical part of a door	350		3	3	—

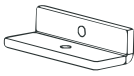
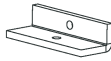
Table NO.2

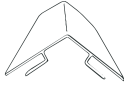
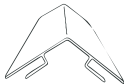
NR.	Name	Length (mm)	Photo	Box 2/2		Box 2/2
				BASE Packaging of archs		EXTENSION Packaging of archs
				Greenhouse area		2m EXTENSION
				4,98m ² 2,35x2,12m	7,45m ² 2,35x3,17m	
2000x1100x140 mm 50 kg	2000x1100x140 mm 50 kg	2000x1100x140mm 25kg				
Number in package (pcs.)						
NR. 17	Foundation angles			4	4	—
NR. 18	Foundation connection plates	3120		—	—	4









TITAN Classic 480

Table NO.2

NR.	Name	Length (mm)	Photo	Box 2/2 BASE Packaging of archs		Box 2/2 EXTENSION Packaging of archs
				Greenhouse area		2m EXTENSION
				4,98m ² 2,35x2,12m	7,45m ² 2,35x3,17m	
				2000x1100x140 mm 50kg	2000x1100x140mm 50kg	2000x1100x140mm 25kg
Number in package (pcs.)						
NR. 19	Polycarbonate connection angles (large angle)			14	14	—
NR. 20	Fixation angles of polycarbonate and stands (small angle)			8	8	—
NR. 21	Polycarbonate connection plates (with 2 holes)			5	5	—
NR. 22	Ridge for 2,12 m length greenhouse	2120		1	—	—
NR. 23	Ridge for 3,17m length greenhouse	1590		—	2	—
NR. 24	Ridge for greenhouse extension	2005		—	—	1
NR. 25	Set of handles			3	3	—
NR. 26	2.15x12 mm screw (yellow)	12		3	3	—
NR. 27	M5-12 bolts with pan head	12		295	351	120
NR. 28	M5-16 screws	16		49	61	24

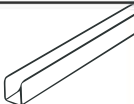

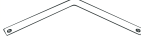
TITAN Classic 480

Table NO.2

NR.	Name	Length (mm)	Photo	Box 2/2 BASE Packaging of archs		Box 2/2 EXTENSION Packaging of archs
				Greenhouse area		2m EXTENSION
				4,98m ² 2,35x2,12m	7,45m ² 2,35x3,17m	
				2000x1100x140 mm 50kg	2000x1100x140mm 50kg	2000x1100x140 mm 25 kg
Number in package (pcs.)						
NR. 29	M5-40 screws	40		126	154	56
NR. 30	Screws M5			470	566	200
NR. 31	Gasket, transparent (round, 4cm diameter)			137	161	48
NR. 32	Plastic connecting H-profile	1470		2	4	4
NR. 33	Plastic connecting H-profile	1320		2	4	4
NR. 34	Ending U-profile (flexible) or breathing strip			8,02m	10,14m	4,02m
NR. 35	Eyelet bolt with a holder			3	3	—
NR. 36	Sealing rubber (grey)	m		12	12	—
NR. 37	Ridge fixing holders			2	2	2
NR. 38	Ending F-profile holders	20x140		4	6	2

TITAN Classic 480

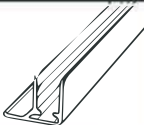
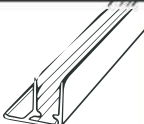
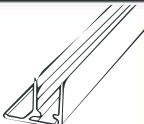
Table NO.2

NR.	Name	Length (mm)	Photo	Box 2/2		Box 2/2
				BASE Packaging of archs		EXTENSION Packaging of archs
				Greenhouse area		2m EXTENSION
				4,98m ² 2,35x2,12m	7,45m ² 2,35x3,17m	
2000x1100x140 mm 50kg	2000x1100x140mm 50kg	2000x1100x140mm 25kg				
Number in package (pcs.)						
NR. 39	F-profile for 3,17m greenhouse	1590		—	4	—
NR. 40	F-profile for 2,12m greenhouse	2120		2	—	—
NR. 41	F-profile for extension	2010		—	—	2
NR. 42	Ridge connection plate			—	1	1

POLYCARBONATE DIMENSIONS

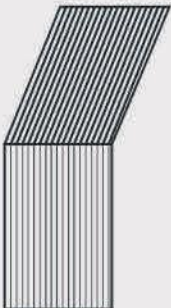
Name	Photo	Height/width, mm	2,35x2,12 m	2,35x3,17 m	2,35x2,00 m
Polycarbonate parts for a roof		1050x1365	4	6	—
Polycarbonate parts for a roof		985x1365	—	—	4
Polycarbonate parts for walls		1050x1485	4	6	—
Polycarbonate parts for walls		985x1485	—	—	4
Side parts for the front and the end		700x1950	4	4	—
Bottom part of the door		960x1230	1	1	—
Upper part of the door		960x650	2	2	—
Triangle (above the door)		920x400	2	2	—
Polycarbonate part below the window		1020x1230	1	1	—

INSTALLATION COURSE:

1. Foundation assembly. To assemble the foundation we use the front and the back parts of the foundation (16) and side parts of the foundation depending on the greenhouse being purchased (13, 14 or 15). All 4 parts should be connected into a rectangle with the foundation angles (17) by manually tightening loosely these entire parts with M5-12 bolts (27), M5 nuts (30) (Fig. 1.1-1.5)

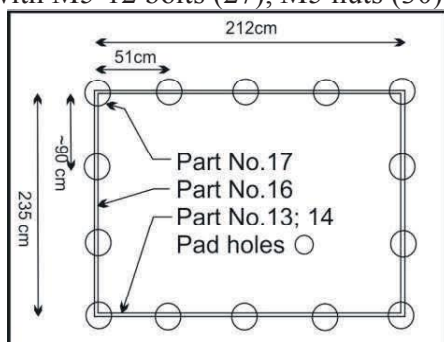

Fig. 1.1

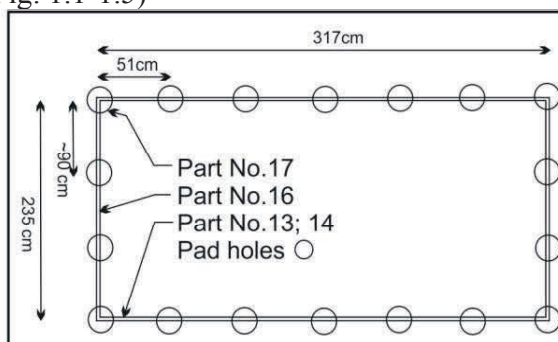

Fig. 1.2



Fig. 1.3



Fig. 1.4

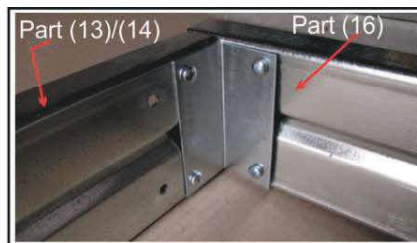

Fig. 1.5

Dimensions:

Width 2.35m, length 2.12m (exterior) bars 5 pieces (4.98m²).

Width 2.35m, length 3.17m (exterior) bars 7 pieces (7.45m²).

Width 2.35m, length 2.00m (exterior) bars 4 pieces (extension).

Foundation connection plates (18) are used for extension of the foundation if TITAN Classic 480 greenhouse length exceeds 2.12 m or 3.17 m. They are fixed from both sides with M5-12 bolts (27), M5 nuts (30) (Fig. 1.6).

If length of the greenhouse is 4.12 m, the foundation is connected as follows: 2.12 m (14) + 2 m extension of the side of the foundation (15).

If length of the greenhouse is 5.17 m, the foundation is connected as follows: 3.17 m (13) + 2 m extension of the foundation (15).

If length of the greenhouse is 6.12 m, the foundation is connected as follows: 2.12 m (14) + 2 m extension of the foundation (15) + 2 m extension of the foundation (15).

If length of the greenhouse is 7.17 m, the foundation is connected as follows: 3.17 m (13) + 2 m extension of the foundation (15) + 2 m extension of the foundation (15), and etc.



Fig. 1.6

2. Measure the diagonal of the foundation. Lengths of diagonals must be equal. If diagonals are equal, tighten the bolts of the foundation fully (Fig. 2).

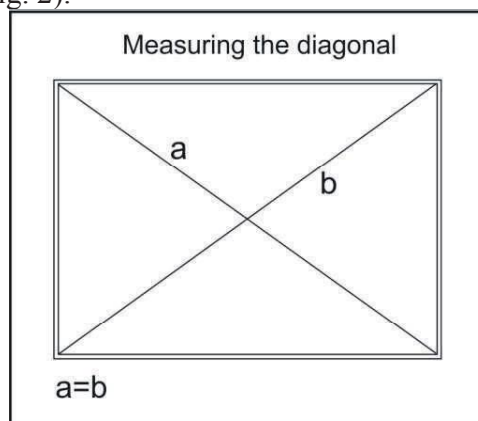

Fig. 2

3. Dig holes (25 cm diameter, 40 cm depth) around the whole perimeter of the foundation near fixing points made in the foundation in order to dig in side – lower bars (No. 1) (Fig. 3)

- 2.12 m – 5 holes (on the sides)
- 3.17 m – 7 holes (on the sides)
- 4.12 m – 9 holes (on the sides)
- 5.17 m – 11 holes, and etc.

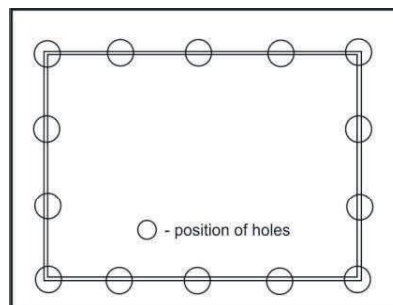

Fig. 3

4. Tighten the polycarbonate connection plates (21) to the front and back parts of the foundation (16) with M5-12 bolts (27) and M5 nuts (30) (Fig. 4.1 - 4.2).

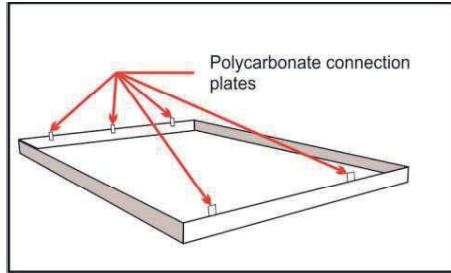

Fig. 4.1



Fig. 4.2

5. Preparation to dig the bar into the ground. Tighten the fixtures into the ground (No. 4) to the bottom of the side - lower bar (No. 1) and the door back bars (No. 8) with M5-12 bolts (27) and M5 nuts (30) (Fig. 5).



Fig. 5

6. Tighten the prepared side - lower bars (No. 1) to the side parts of the assembled foundation with M5-12 bolts (27) and M5 nuts (30) (Fig. 6.1 – 6.3).

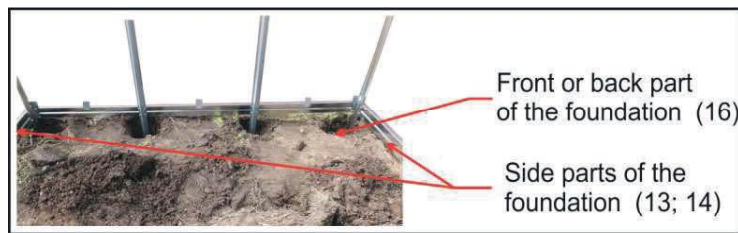

Fig. 6.1



Fig. 6.2



Fig. 6.3

7. Side - lower bars (No. 1) are fixed by tightening the bar fixing cross bars depending on the length of the greenhouse (No. 5, No. 6 or No. 7) with M5-12 bolts (27) and M5 nuts (30) (Fig. 10). The same action is to be carried out on both sides (Fig. 7.1 – 7.2).

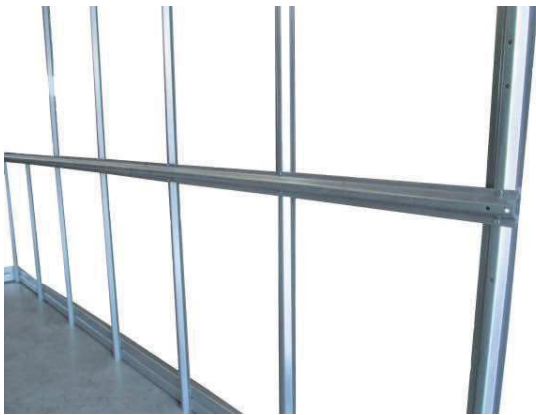

Fig. 7.1



Fig. 7.2

To fix the bars of TITAN Classic 480 greenhouse that is longer than 2.12 m or 3.17 m additional cross bars are used.

If greenhouse length is 4.12 m – cross fastening of the bars is connected as follows: 2.12 m (No. 6) + 2.07 m (No. 7).

If greenhouse length is 5.17 m – cross fastening of the bars is connected as follows: 3.17 m (No. 5) + 2.07 m (No. 7).

If greenhouse length is 6.12 m – cross fastening of the bars is connected as follows: 2.12 m (No. 6) + 2.07 m (No. 7) + 2.07 m (No. 7).

If greenhouse length is 7.17 m – cross fastening of the bars is connected as follows: 3.17 m (No. 5) + 2.07 m (No. 7) + 2.07 m (No. 7).

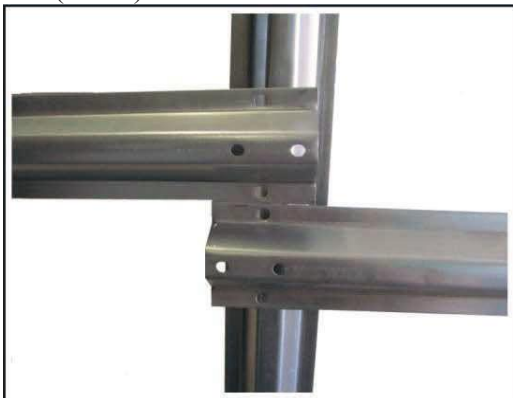

Fig. 7.3



Fig. 7.4

8. Separately connect the upper bars (No. 2) to the connectors of the upper bar (a plate with 4 holes) (12) with M5-12 bolts (27) and M5 nuts (30), then tighten the ridge fixtures (No. 3) in places meant for this with M5-20 bolts (28) and M5 nuts (30). The same action is to be carried out with all bars (Fig. 8.1 – 8.4).

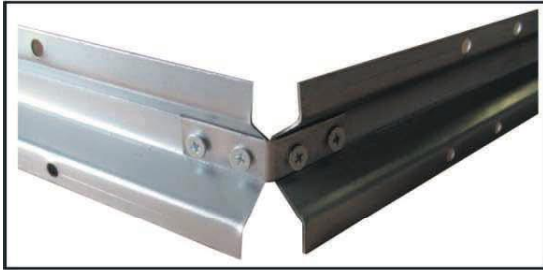

Fig. 8.1

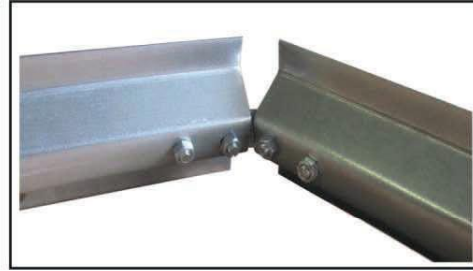

Fig. 8.2

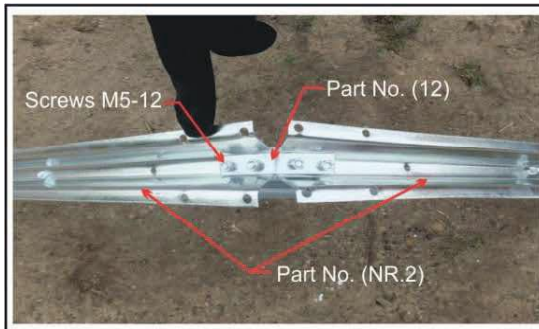

Fig. 8.3

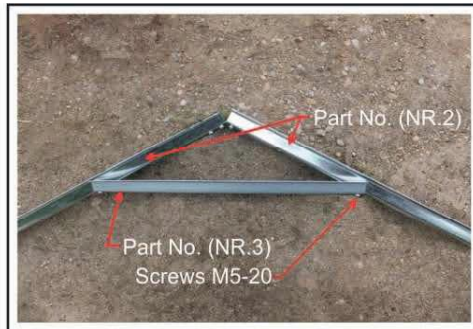

Fig. 8.4

9. The assembled and fixed upper bars (No. 2) are tightened to the upper parts of the side – lower bars (No. 1) with M5-12 bolts (27) and M5 nuts (30) with the bar connection plates (12) (Fig. 9.1 – 9.3).

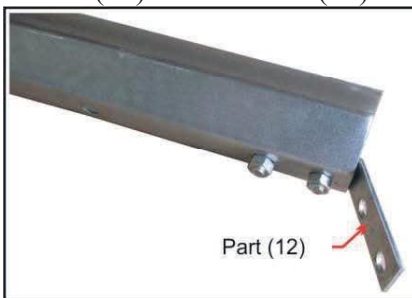

Fig. 9.1

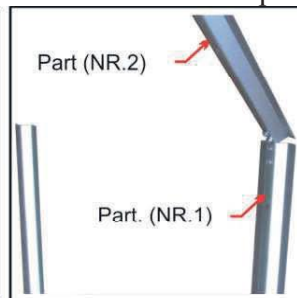

Fig. 9.2

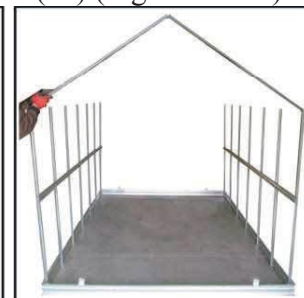

Fig. 9.3

10. Fix the side (No. 1) and the upper bars (No. 2) to each other by fixing profiles for sides and a ridge (No. 3) with M5-20 bolts (28) and M5 nuts (30). The same action is to be carried out with all bars (Fig. 10.1 – 10.2).

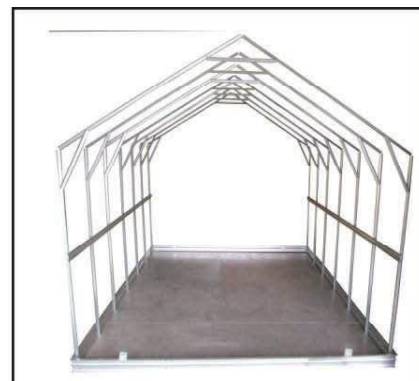
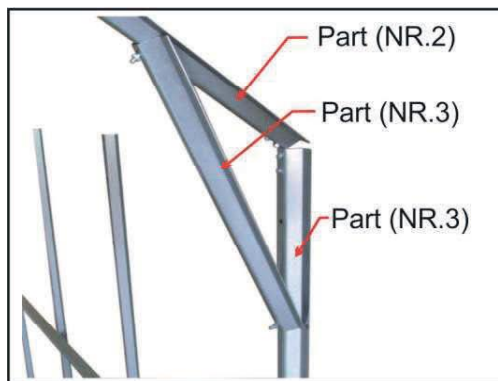

Fig. 10.1

Fig. 10.2

11. Tighten the remaining fixing cross bars (No. 5; No. 6 or No. 7) to the upper bars (No. 2) with M5-12 bolts (27) and M5 nuts (30) (Fig. 11.1 – 11.3).



Fig. 11.1



Fig. 11.2

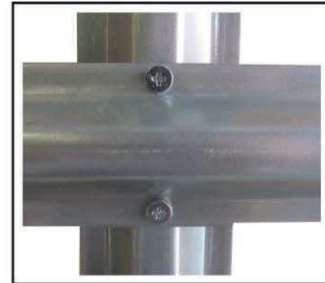

Fig. 11.3

12. Tighten the polycarbonate connection angles (19) and the bar connection angles (20) to the side – lower bars (No. 1), the upper bars (No. 2), and the side bar cross bars (No. 4; No. 5 or No. 6) with M5-12 bolts (27) and M5 nuts (30) (Fig. 12.1 – 12.2).

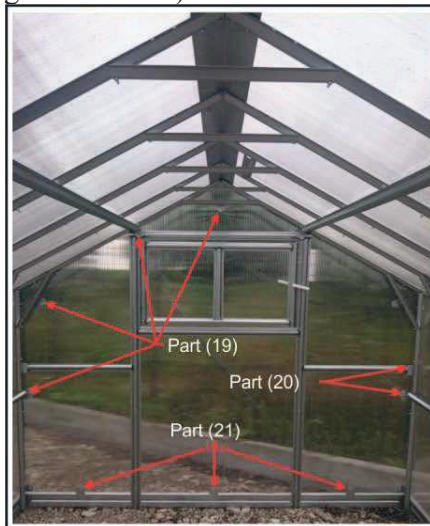

Fig. 12.1

NOTE:

The position and arrangement of the angles are in consecutive order from the bottom to the top. The other side is to be handles analogically. The place meant for the door: in that place the polycarbonate connection plate (21) is not to be fixed in the middle.



Fig. 12.2

13. Tighten the door and back bar holders (No. 9) in the front and at the back of the large angles (19) tightened to the ends of upper bar fixtures (No. 5; No. 6 or No. 7) with M5-12 bolts (27) and M5 nuts (30). This action is carried out analogically in the front and at the back (Fig. 13.1 – 13.3).

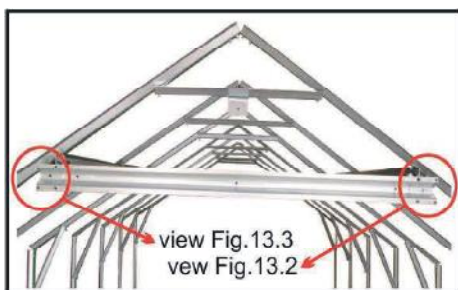

Fig. 13.1



Fig. 13.2



Fig. 13.3

14. Tighten the door and back bars (No. 8) to the door and back bar holders (No. 9). The upper part of the bar is to be fixed to the door and back bar holders (No. 9), and the lower part is to be fixed to the front part of the

foundation (16) with M5-12 bolts (27) and M5 nuts (30). This action is carried out analogically in the front and at the back (Fig. 14.1 – 14.4).

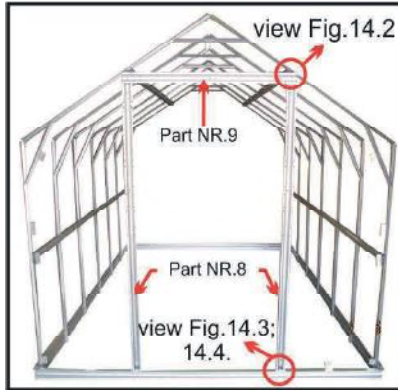

Fig. 14.1



Fig. 14.2



Fig. 14.3



Fig. 14.4

15. In the front and at the back of the greenhouse tighten the door and back fixtures (No. 10) to the door and back bars (No. 8) with M5-12 bolts (27) and M5 nuts (30). Additionally, at the back of the greenhouse between the door and back bars (No. 8) tighten the rear part fixture (No. 11) (Fig. 15.1 – 15.7).

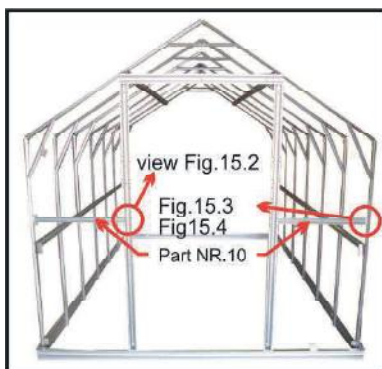

Fig. 15.1



Fig. 15.2

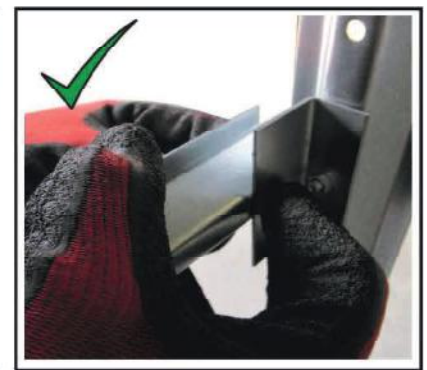

Fig. 15.3



Fig. 15.4



Fig. 15.5



Fig. 15.6

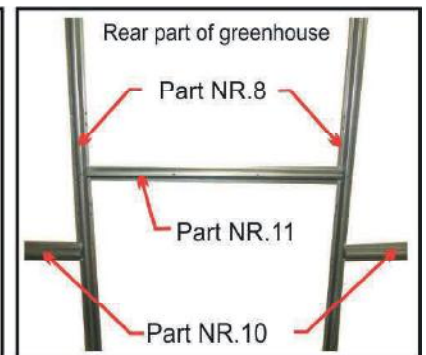

Fig. 15.7

16. As during assembly of the greenhouse the bolts have been tightened loosely in order to be able to easily move profiles, if needed, the next step is to adjust the assembled frame of the greenhouse with the level, to check the diagonal once again, to tighten bolts fully, and only after that to fill up the holes (Fig. 16).



Fig. 16

Be careful not to mix sides of polycarbonate! Fasten it with a set side to the outside, where there is a UV rays protection layer. UV rays protection layer is coated by a film with inscriptions; another side (being installed to the inside) is coated by a transparent film. It is recommended to cut sheets with an electric circular saw, a hand saw with small teeth, a sharp knife, if necessary. Before installation it is necessary to remove films! SAFETY GLOVES ARE NECESSARY TO WEAR WHEN CUTTING SHEETS!

17. Upon tightening the frame part of the greenhouse installation of polycarbonate is to be started. Start fixing polycarbonate sheets from the rear part of the greenhouse. Apply the part of back wall polycarbonate sheet below window (1020x1230 mm) to the frame on the back side of the greenhouse and tighten it with M5-40 bolts (29), M5 nuts (30), and gaskets (31). Through connection plates (21) polycarbonate is tightened with M5-20 bolts (27), M5 nuts (30), and gaskets (31). Then cut polycarbonate near the frame profile with a sharp knife or a jigsaw, if necessary. Upper polycarbonate channels in the part below window depending on configuration are sealed by U-profile or breathing strip (34) (Fig. 17.1 – 17.4).



Fig. 17.1

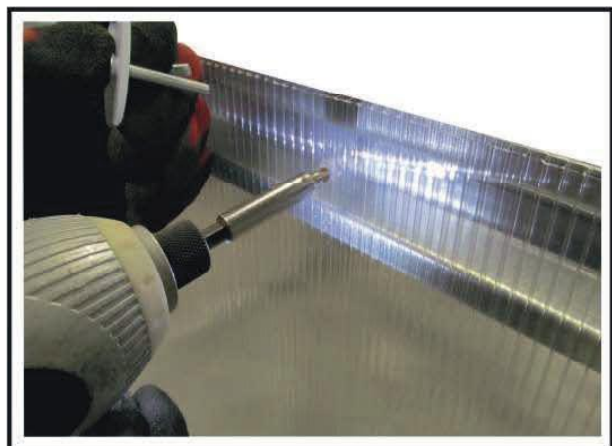

Fig. 17.2

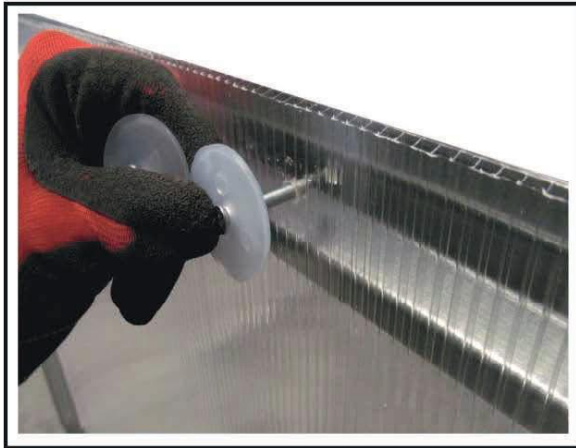

Fig. 17.3



Fig. 17.4

18. The side parts of polycarbonate for the back and the front are fixed analogically. We apply the polycarbonate sheet (700x1950 mm) evenly with an edge of an opening near the door and the back bars and evenly with the foundation. The polycarbonate sheet is tightened to the bar connection angles (19; 20) and the polycarbonate connection plates (21) with M5-20 bolts (28), M5 nuts (30), and gaskets (31). The sheet is tightened to the bars of the rear part of the greenhouse (No. 8) and the bar fixtures (No. 9, No. 10, and No. 11) with M5-40 bolts (29), M5 nuts (30), and gaskets (31). Then cut polycarbonate near the frame profile with a sharp knife or a jigsaw, if necessary (Fig. 18.1 – 18.4).

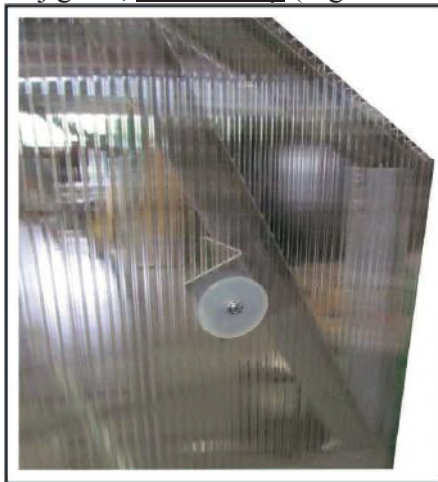

Fig. 18.1

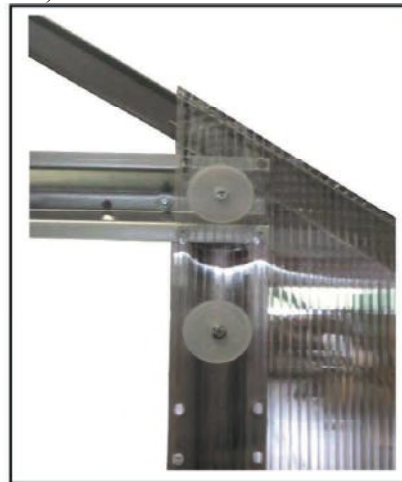

Fig. 18.2



Fig. 18.3



Fig. 18.4

19. At the front and at the back of the greenhouse above the door and back bar holder (No. 9) polycarbonate-triangle (400x920 mm) covers by its edges side polycarbonate parts and is tightened to the frame with M5-40 bolts (29), M5 nuts (30), and gaskets (31), and to bar connection angles - with M5-20 bolts (28), M5 nuts (30), and gaskets (31). Then cut polycarbonate near the frame profile with a sharp knife or a jigsaw, if necessary (Fig. 19.1 – 19.2).



Fig. 19.1

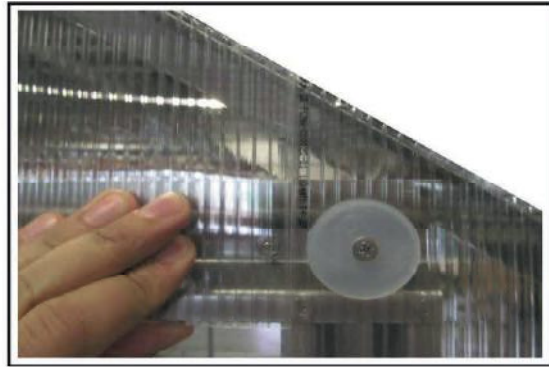

Fig. 19.2

20. Apply sealing rubber (36) on the top of channels of side polycarbonate sheets at the top and on the sides of the front and the rear parts of the greenhouse, and only after that put side and upper parts of polycarbonate (Fig. 20.1 – 20.5).

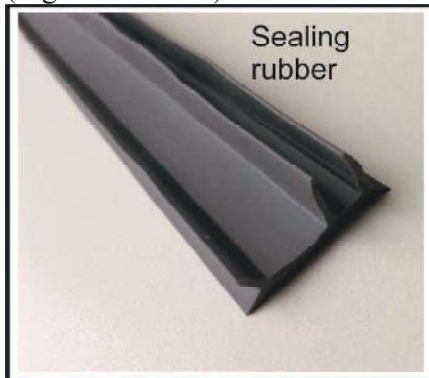

Fig. 20.1



Fig. 20.2

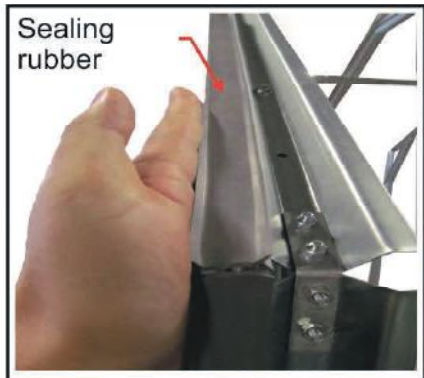

Fig. 20.3



Fig. 20.4



Fig. 20.5

21. Wall covering installation. 1050x1485 mm and/or 980x1485 mm (extending sheets) polycarbonate sheets are used to cover the walls.

Sheet arrangement side view (for walls and roof):

2.12 m length: 1.05+1.05 m (Fig. 21.1)

3.17 m length: 1.05+1.05+1.05 (Fig. 21.2)

4.12 m length: 1.05+0.985+0.985+1.05 m (Fig. 21.3)

5.17 m length: 1.05+1.05+0.985+0.985+1.05 m (Fig. 21.4)

6.12 m length: 1.05+0.985+0.985+0.985+0.985+1.05 m (Fig. 21.5), and etc. €

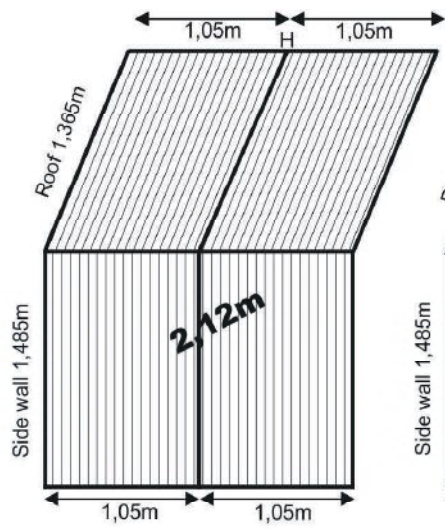

Fig. 21.1

H

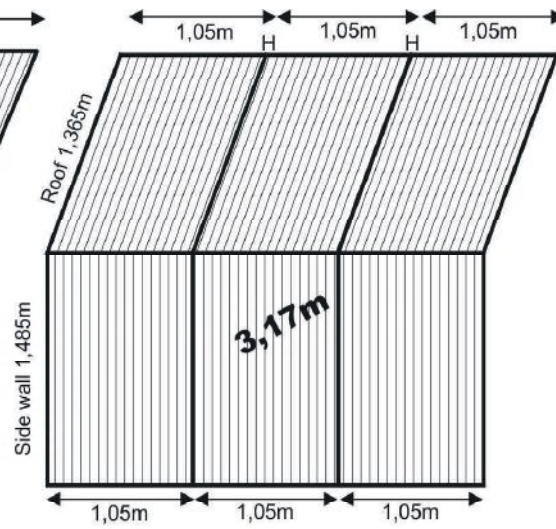

Fig. 21.2

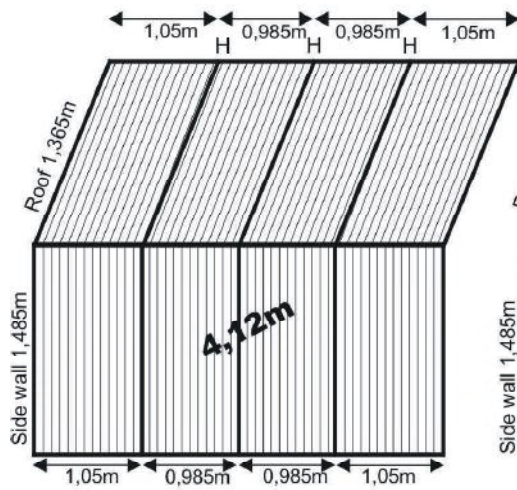

Fig. 21.3

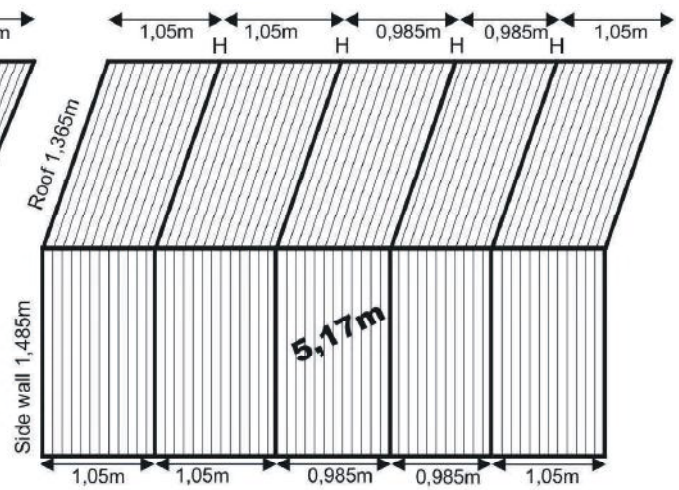

Fig. 21.4

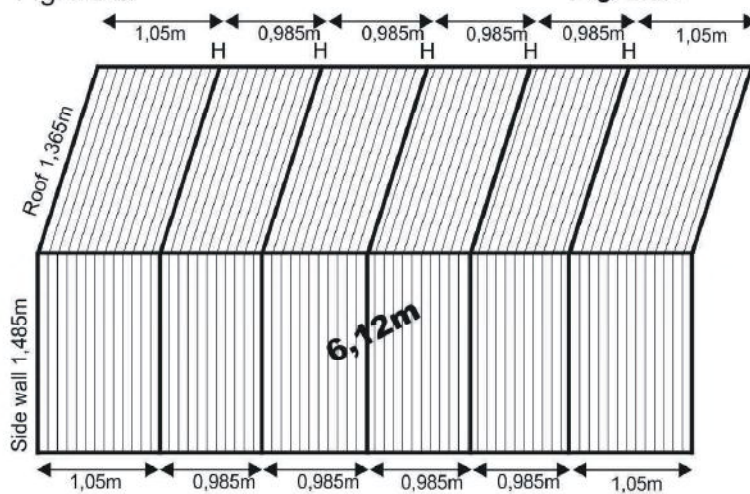

Fig. 21.5

The sheets are connected to each other by connecting H-profiles (32), which are tightened to the 3rd bar (for the greenhouse of 2.12 m length) from one and another side of the greenhouse by their flat part with M5-40 bolts (29), M5 nuts (30), and gaskets (31). The holes made in the H-profile must match the holes made in the frame. If the greenhouse is longer than 2.12 m, the H-profiles are to be tightened to the bars as follows, starting from the front of the greenhouse:

- | | |
|--------|--|
| 3.17 m | 3 rd and 5 th bars |
| 4.12 m | 3 rd , 5 th , and 7 th bars |
| 5.17 m | 3 rd , 5 th , 7 th , and 9 th bars, and etc. |

ATTENTION! *Remove the protective film from the connecting profiles, if any!*

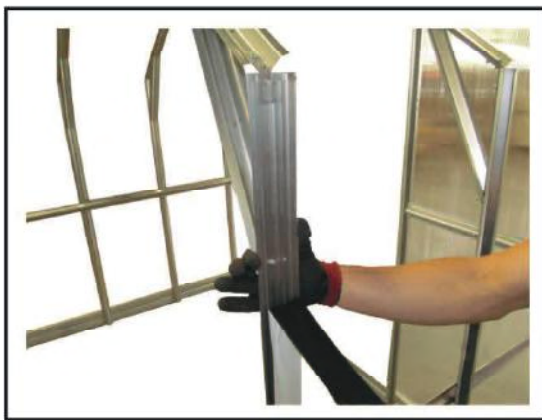

Fig. 21.6



Fig. 21.7

To cover the walls of 4.12 m length TITAN Classic 480 greenhouse 2 sheets of 1050x1485 mm and 2 sheets of 985x1485 mm are needed. The sheets are inserted into the connecting H-profiles downward from the top. Polycarbonate edges at the front and at the back must overhang up to the edge of the foundation. The sheets are tightened to the frame with M5-40 bolts (29), M5 nuts (30), and gaskets (31) (Fig. 21.8 – 21.11).



Fig. 21.8



Fig. 21.9



Fig. 21.10



Fig. 21.11

A plate protection tape or flexible ending U-profiles (34) are applied to the upper end of these sheets. The bottom ends of the sheets are to be left open (21.12 – 21.13).



Fig. 21.12



Fig. 21.13

22. Polycarbonate roofing installation. 1050x1485 mm and/or 980x1485 mm (extending sheets) polycarbonate sheets are used for roofing.

The sheets are connected to each other by connecting H-profiles (33), which are tightened to the 3rd bar (for the greenhouse of 2.12 m length) from one and another side of the greenhouse by their flat part with M5-40 bolts (29), M5 nuts (30), and gaskets (31). The holes made in the H-profile must match the holes made in the frame. If the greenhouse is longer than 2.12 m, the H-profiles are to be tightened to the bars as follows, starting from the front of the greenhouse:

3.17 m	3 rd and 5 th bars
4.12 m	3 rd , 5 th , and 7 th bars
5.17 m	3 rd , 5 th , 7 th , and 9 th bars, and etc.

ATTENTION! Remove the protective film from the connecting profiles, if any!

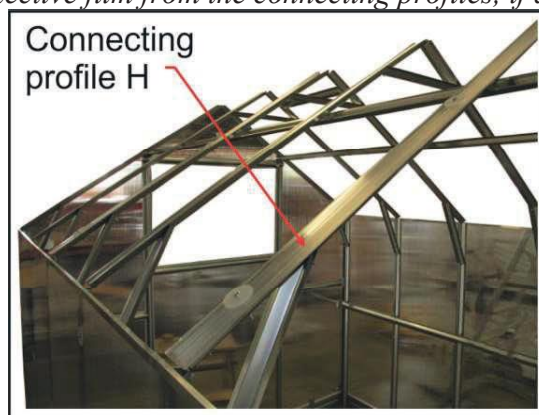

Fig. 22.1

For instance, to cover the roof of 4.12 m length TITAN Classic 480 greenhouse 2 sheets of 1050x1485 mm and 985x1485 mm (2 sheets) are needed. The sheets are inserted into the connecting H-profiles upward from the bottom. Polycarbonate edges at the front and at the back must overhang up to the edge of the foundation. The sheets are tightened to the frame with M5-40 bolts (29), M5 nuts (30), and gaskets (31) (Fig. 21.8 – 21.11).



Fig. 22.2

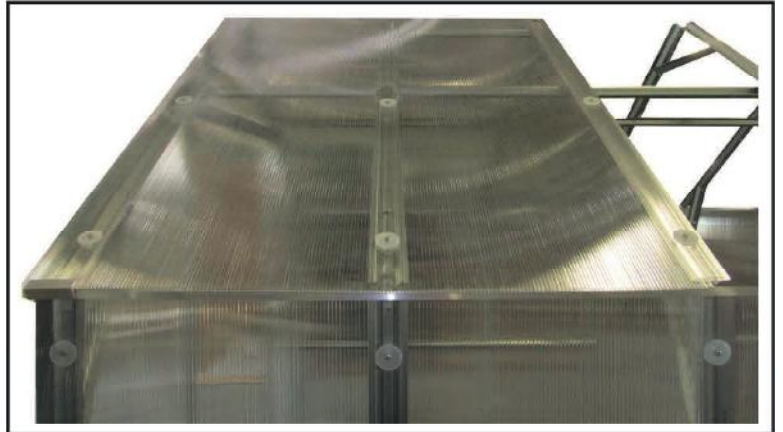

Fig. 22.3

The upper ends of the sheets fit into the ridge (22; 23). Ending F-profiles, which are fixed by F-profile holders (38), are put onto the lower ends of the sheets (39; 40, and 41) (Fig. 22.4 – 22.7). The holders are tightened to the frame with M5-40 bolts (29), M5 nuts (30), and gaskets (31).

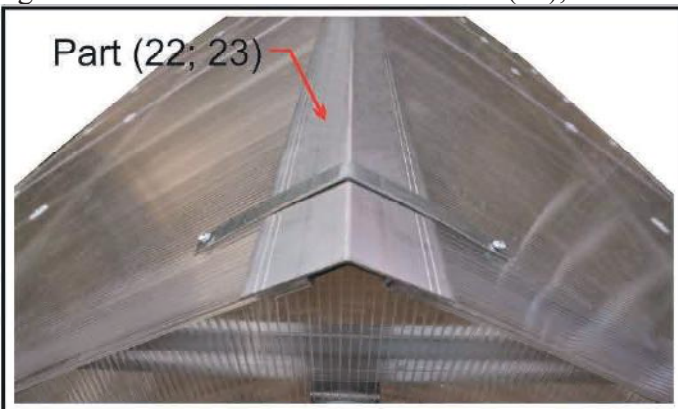

Fig. 22.4

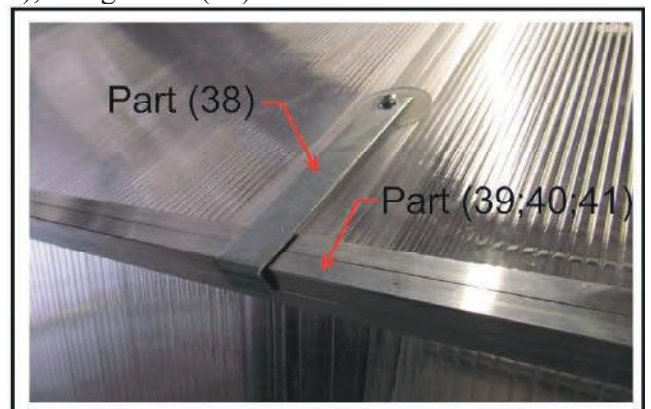

Fig. 22.5



Fig. 22.6

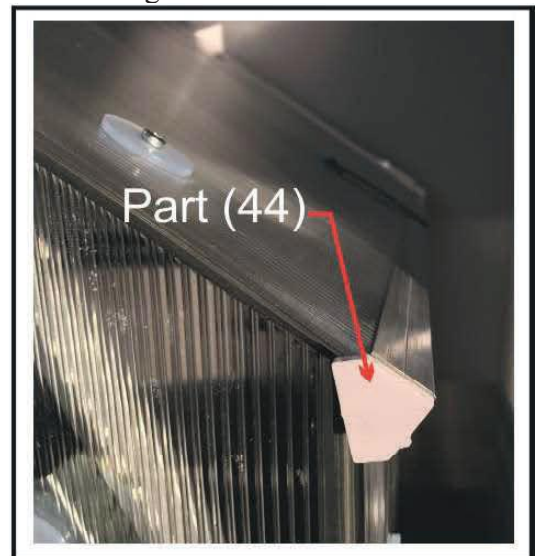

Fig. 22.7

23. Fix the ridge (22; 23 or 24) by means of the ridge fixing holders (37; 42) with M5-40 bolts (29) and M5 nuts (30). At the edges the ridge is fixed by means of narrow holders (37), and in the middle near ridge connection – by means of a broad holder (42) with M5-40 bolts (29), M5 nuts (30), and gaskets (31) (23.1 – 23.2). In front and rear of ridge, to put ridge covers (43).

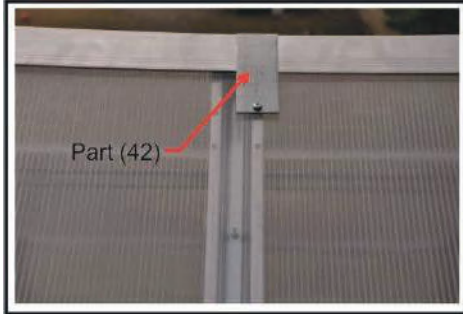

Fig. 23.1

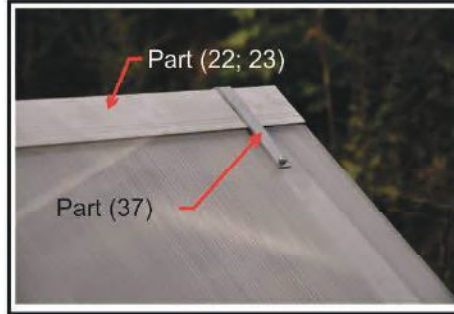

Fig. 23.2



Fig. 23.4

24. Assembly of the lower and the upper parts of the door.

Connect all parts supplied in the set of the lower part of the door (DOOR No. 5; DOOR No. 6; DOOR No. 3) into a rectangle with M5-12 bolts (27) and M5 nuts (30). Tighten vertical parts of the door to the assembled frame (DOOR No. 7) (Fig. 24.1).

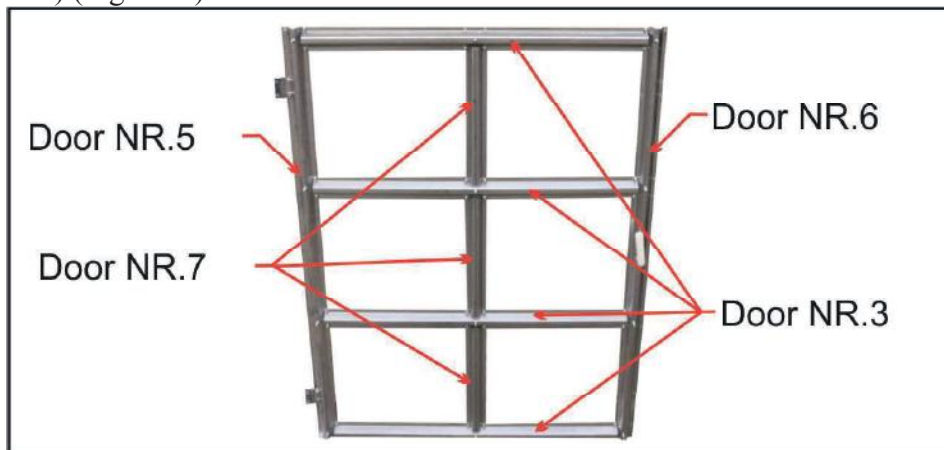

Fig. 24.1

Connect all parts supplied in the set of the upper part of the door (DOOR No. 1; DOOR No. 2; DOOR No. 3) into a rectangle with M5-12 bolts (27) and M5 nuts (30). Tighten vertical parts of the door to the assembled frame (DOOR No. 4) (Fig. 24.2).

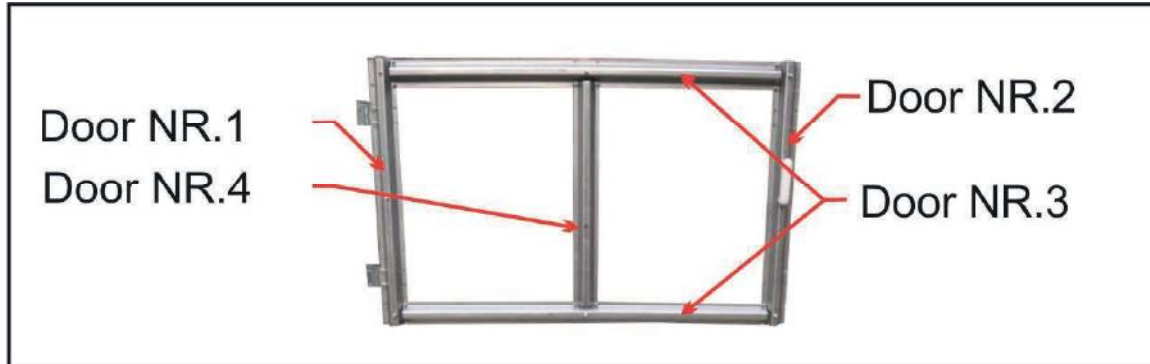

Fig. 24.2

The door to be mounted on the bars through cellular polycarbonate with M5-12 bolts (27) and M5 nuts (30) must be fully opened and its hinge must be directed outside the opening (Fig. 24.3).



Fig. 24.3

Tighten polycarbonate of the lower (960x1230mm) and upper (960x650mm) part of the door to the fixed frame parts of the door with M5-40 bolts (29), M5 nuts (30), and gaskets (31) (Fig. 24.4). **NOTE: polycarbonate covering of the upper door overhangs the lower door.**

Upper polycarbonate channels of the door depending on configuration are to be sealed by the plate protection strip or the ending aluminium U-profile (42). Attach the handle (25) to the prepared place of the door (Fig. 24.5).



Fig. 24.4

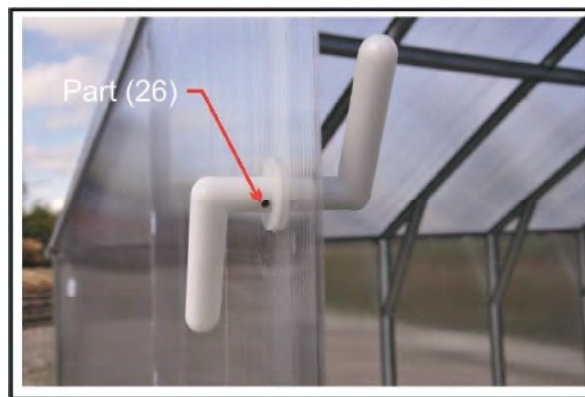

Fig. 24.5

25. Tighten the eyelet bolt (35) into a place intended for that (on the same level with the upper door-window handle). Make a loop from the door opening holder supplied to you (35). Eyelets of all opening-closing doors are made at the handle level with M5 nuts (30) and gaskets (31) (Fig. 25.1 – 25.2).



Fig. 25.1



Fig. 25.2

Contact information

Austria



Belgium



Croatia



Denmark



Estonia



Finland



France



Germany



Ireland



Italy



Latvia



Lithuania



Nederland



Norway



Poland



Portugal



Spain



Sweden



Switzerland



UK

